



ESPRIT
NEIGE



EDA



EDITO

La dynamique d'innovation, l'exigence qualité et la responsabilité environnementale permettent à EDA d'être, depuis 1946, un intervenant majeur sur le marché européen des articles en plastique de grande consommation. Nous proposons des solutions pour l'équipement de la maison, du jardin, des loisirs et de l'aménagement extérieur. Avec plus de 70 machines et 83 000 m² de surface de stockage, notre société se révèle comme un partenaire fiable pour l'avenir.

Un futur que nous souhaitons également durable en assumant entièrement notre responsabilité environnementale et sociétale dans tous les aspects de notre travail quotidien. Tous les produits EDA, fabriqués à partir de polyoléfine, sont 100% recyclables.

Parce qu'EDA a mis la fabrication française au cœur de ses priorités en fabriquant ses produits à Oyonnax (Ain 01), site historique depuis plus de 70 ans et essentiellement par des collaborateurs locaux, la marque s'est vu décerner le label Origine France Garantie sur la majorité de ses produits, en reconnaissance de son engagement industriel et gage de la qualité de ses produits.



The dynamics of innovation, quality requirements and environmental responsibility assure to EDA, since 1946, to be a major player on the European market for mass consumption plastic products. We offer solutions for Home, Garden, Leisure and Outdoor.

With over 70 machines and 83 000m² of logistic area, our company is suppose to be a reliable partner for the future. A future we also want sustainable by fully assuming our social and environmental responsibility in all aspects of our daily work. All the products EDA made with polyolefin are 100% recyclable.

Die Erneuerungsdynamik, die Qualitätsforderung und die ökologische Verantwortlichkeit erlauben der Firma EDA, seit 1946, ein Hauptbeteiligter im Bereich von Kunststoff Produkten auf dem europäischen Markt zu sein. Wir schlagen Lösungen für Haus – Garten – Freizeit Ausrüstungen und äussere Einrichtungen vor.

Mit mehr als 70 Maschinen und eine Lagerfläche von 83 000 m², stellt unsere Gesellschaft ein zuverlässigen Partner für die Zukunft dar.

Bei Annahme von unserer ökologischen und gesellschaftliche Verantwortlichkeit in jeder Ansicht von unserer täglichen Arbeit, wünschen wir wir dass diese Zukunft dauerhaft bleibt. Alle EDA Produkte hergestellt mit Polyolefin, sind 100% recyclebar.

Una constante innovación, la exigencia de calidad y la responsabilidad del medio ambiente permiten a EDA de ser, desde 1946, un actor principal del mercado europeo sobre la venta de artículos de plástico de gran consumo.

Proponemos soluciones para el equipo del hogar, el jardín, de los ocios así como para el mobiliario y decoración exterior. Con más de 70 máquinas y 83 000m² de superficie de almacenamiento, nuestra empresa se revela como un socio fiable para el porvenir. Un futuro que deseamos sostenible y durable asumiendo totalmente nuestra responsabilidad con el medio ambiente y sociedad en todos los aspectos de nuestro trabajo diario. Todos los productos EDA fabricados con polyolefina son 100% reciclables.





SOMMAIRE

LUGES 04

*SLEIGHS
SCHLITTEN
TRINEOS*

ACCESSOIRES DE DÉNEIGEMENT 10

*SNOW ACCESSORIES
SCHNEERÄUMARBEITEN GERÄTE
ACCESORIOS DE LA NIEVE*



LUGES

SLEIGHS
SCHLITTEN
TRINEOS



10765

INFORMATIONS TECHNIQUES

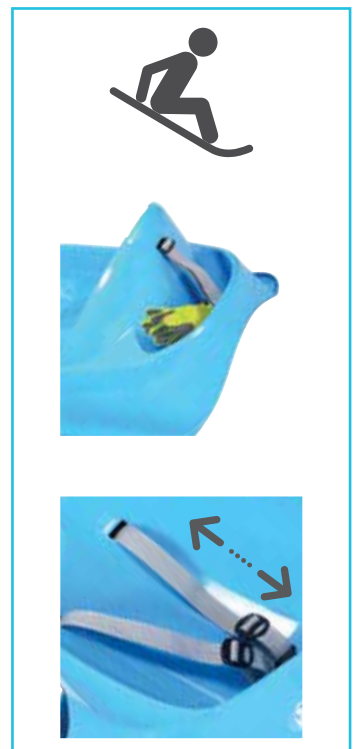

**TRINEAU LUGE «BOBEE BOB»
AVEC HARNAIS ET SANGLE TIRE LUGE**

Sleigh with rope and grip
Schlitte mit Schlittengriff
Trineo con cinturón de seguridad y asa montados

66

RÉF.	10765
DIM. L x l x H (CM)	79 x 51 x 40
U.E.	S.4



INFORMATIONS TECHNIQUES
REF. 1003



1003



903

INFORMATIONS TECHNIQUES
REF. 19975



19975

LUGE 2 PLACES AVEC FREINS ET TIRE LUGE MONTÉS

2 seats with handles brakes & grip assembled
2 Plätze mit montierten Bremsen und Schlittengriff
2 asientos con frenos y asa montados

66 **15** RÉF. 1003
DIM. L x l x H (CM) 88 x 44 x 20.5
U.E. S.6

LUGE PLATEAU AVEC FREINS ET TIRE LUGE MONTÉS

Flat sleigh with handles brakes and grip assembled
Schlittenplatte mit montierten Bremsen und Schlittengriff
Trineo plató con frenos y asa montados

66 **15** RÉF. 19975
DIM. L x l x H (CM) 90 x 48 x 18
U.E. S.4

LUGE 1 PLACE AVEC FREINS ET TIRE LUGE MONTÉS

1 seat with handles brakes & grip assembled
1 Platz mit montierten Bremsen und Schlittengriff
1 asiento con frenos y asa montados

66 **15** RÉF. 903
DIM. L x l x H (CM) 76 x 43 x 19
U.E. S.6



56

INFORMATIONS TECHNIQUES
REF. 19976

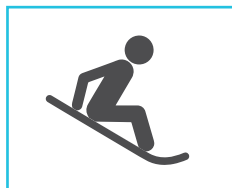

19976



19804

INFORMATIONS TECHNIQUES
REF. 19804

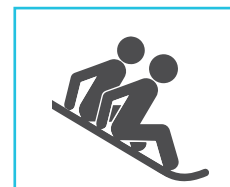

SUPER BOB EDA N°56 AVEC VOLANT, 2 PATINS, FREINS ET TIRE LUGE MONTÉS

1 seat with wheel and 2 skates, handles brakes and grip assembled
1 Platz mit montierten Lenkrad und 2 Kufen, Bremsen und Schlittengriff
1 asiento con volante y 2 patines, frenos y asa montados

15

RÉF. 19976

DIM. Lxl xH(CM) 95 x 48 x 23
U.E. S.2

BOB EDA N°14 AVEC FREINS ET TIRE LUGE MONTÉS

2 seats with assembled handles brakes
2 Plätze mit montierten Bremsen
2 asientos con frenos montados

66

15

RÉF. 19804

DIM. Lxl xH(CM) 95 x 48 x 22
U.E. S.2

X-STYLE



10974

INFORMATIONS TECHNIQUES
REF. 10974



NEVASTAR
5



102300

INFORMATIONS TECHNIQUES
REF. 102300

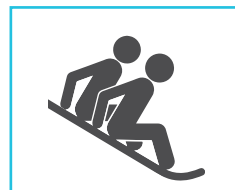

INFORMATIONS TECHNIQUES
REF. 10397

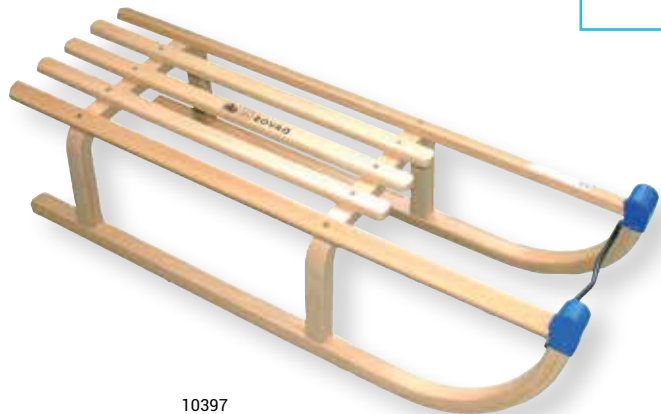

10397

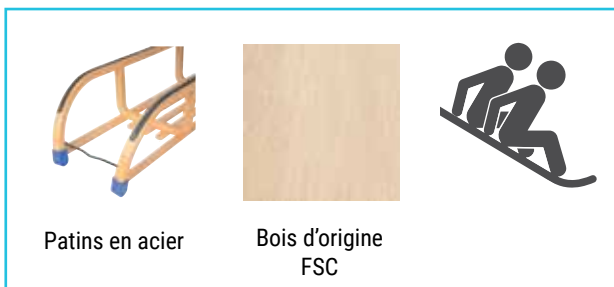

Patins en acier

Bois d'origine
FSC

X-STYLE AVEC FREINS MONTÉS

1 seat with assembled handles brakes
1 Platz mit montierten Bremsen
1 asiento con frenos montados

8

15

RÉF. 10974
DIM. Lxl xH(CM) 80 x 45 x 15
U.E. S.4

«NEVASTAR» 2 PLACES AVEC FREINS ET TIRE LUGE MONTÉS

2 seats with handles brakes and grip assembled
2 Plätze mit montierten Bremsen und Schlittengriff
2 asientos con frenos y asa montados

15

RÉF. 102300
DIM. Lxl xH(CM) 97 x 60 x 16,5
U.E. S.6

LUGE EN BOIS MODÈLE «DAVOS»

Wooden sleigh
Holz Rodel
Trineo de madera

44

RÉF. 10397
DIM. Lxl xH(CM) 90 x 32 x 22,5
U.E. S.2



10891



1004



10893

SPÉCIAL LOCATIONS

ACCESSOIRES



100300

100400



10896

LUGE TOUPIE

«Toupie» Sleigh
Teller Rutscher «Toupie»
Trineo «Toupie»

66

15

RÉF.	10891
DIM. Ø (CM)	ø64
U.E.	S.10

LUGE «PELLE» - COLORIS ASSORTIS

Sliding pan - Mixed colors
Schnee Schippe - Gemischte Farbe
Trineo pala - Colores asortados

40

15

43

9

65

RÉF.	1004	10893
DIM. LxI xH (CM)	49 x 31 x 3	52 x 33,7 x 4
U.E.	S.20	S.10
COMPOSITION	40 15 9 65	40 15 43 9 65

LUGE DE LOCATION «CARBOSTAR»

Sleighs for rental
Vermietungsschlitten
Trineo para alquiler

15

RÉF.	100300	100400
DIM. LxI xH (CM)	93 x 45 x 10	111 x 56 x 10
NB DE PERSONNES	1	2
U.E.	S.3	S.3

TIRE LUGE

Grip
Schlittengriff
Asa

22

RÉF.	10896
DIM. L (CM)	145 avec cordelette
U.E.	C.30



ACCESSOIRES DE DÉNEIGEMENT

SNOW ACCESSORIES

SCHNEERÄUMARBEITEN GERÄTE

ACCESORIOS DE LA NIEVE



INFORMATIONS
TECHNIQUES



10388



INFORMATIONS
TECHNIQUES



10389

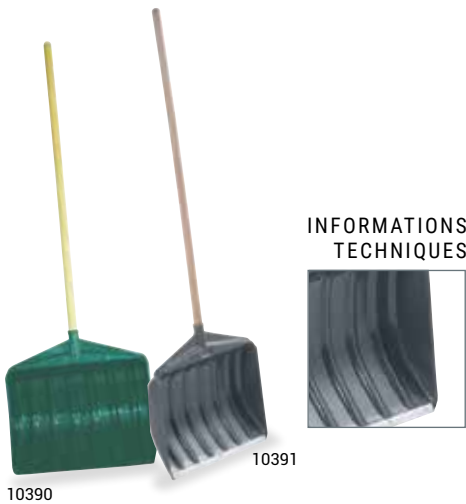

INFORMATIONS
TECHNIQUES

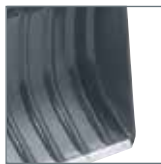

10390

10391



INFORMATIONS
TECHNIQUES



10418

PELLE EN PLASTIQUE, MANCHE EN ALUMINIUM
AVEC GRIP ET POIGNÉE, RENFORT ALU

Aluminium reinforcement
Aluminium Verstärkung
Con refuerzo metálico

22

RÉF.	10388
DIM. L x H (CM)	40 x 32 x 130
U.E.	B.24

PELLE À NEIGE, MANCHE TÉLESCOPIQUE

Telescopique handle
Mit Teleskopstiel
Mango telescópico

30

RÉF.	10389
DIM. L x H (CM)	25 x H73 à 98 x 6,5
U.E.	C.12

PELLE DE RAMASSAGE OU DE DÉNEIGEMENT

Snow shovel
Sammel oder Schneeschaukel
Pala para limpieza de la nieve

RÉF.	10390	10391
DIM. L x H (CM)	46 x 145	46 x 145
U.E.	B.16	B.16

26

30

PELLE ALU, MANCHE EN BOIS
AVEC POIGNÉE PLASTIQUE

Wooden handle
Holzstiel
Mango de madera

29

RÉF.	10418
DIM. L x H (CM)	36 x 45 x 130
U.E.	B.10

QUALITÉ

Parce que la qualité de nos produits demeure notre priorité au quotidien, nous réalisons en interne les tests dynamiques pour les luges.



CRASH TEST

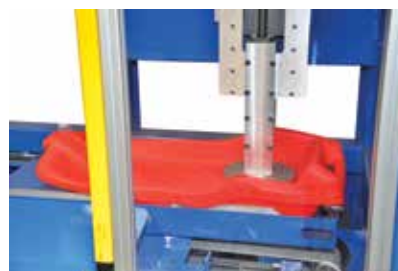
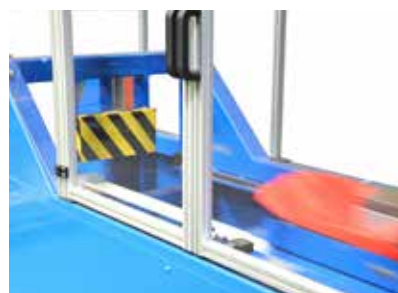

Normes relatives à la sécurité des jouets



- NF EN 71-1
- NF EN 71-2 + A1
- NF EN 71-3 + A2





TRAINEAU LUGE BOBEE BOB



RÉF.	10765
Désignation	TRAINEAU LUGE «BOBEE BOB» AVEC TIRE LUGE
DIM (cm)	79 x 51 x 40
U.E.	S.4
Bleu suédois	  3 086960 246112





LUGES PLATEAUX



RÉF.	19975	903	1003
Désignation	LUGE PLATEAU AVEC TIRE LUGE ET FREINS MONTÉS	LUGE 1 PLACE AVEC TIRE LUGE ET FREINS MONTÉS	LUGE 2 PLACES AVEC TIRE LUGE ET FREINS MONTÉS
DIM (cm)	90 x 48 x 18	76 x 43 x 19	88 x 44 x 20,5
U.E.	S.4	S.6	S.6
Bleu suédois	  3 086960 246808	 3 086960 246129	 3 086960 246136
Rouge	  3 086960 050917	 3 086960 202484	 3 086960 202507

LUGES «BOB»



RÉF.	19804	19976
Désignation	LUGE 2 PLACES «BOB 14» AVEC TIRE LUGE ET FREINS MONTÉS	LUGE 1 PLACE «SUPER BOB 56» AVEC VOLANT, 2 PATINS, TIRE LUGE ET FREINS MONTÉS
DIM (cm)	95 x 48 x 22	95 x 48 x 23
U.E.	S.2	S.2
Bleu suédois	  3 086960 246204	
Rouge	  3 086960 246198	 3 086960 246211





LUGES « RACING »



RÉF.		10974	102300
Désignation		LUGE 1 PLACE «X-STYLE» AVEC FREINS MONTÉS	LUGE 2 PLACES «NEVASTAR» AVEC TIRE LUGE ET FREINS MONTÉS
DIM (cm)		80 x 45 x 15	97 x 60 x 16,5
U.E.		S.4	S.6
Rouge	15		
Gris anthracite	8		

LUGES BOIS



RÉF.		10397
Désignation		LUGE EN BOIS MODELE «DAVOS»
DIM (cm)		90 x 32 x 22,5
U.E.		S.2
Bois	44	

LUGES « TOUPIE »



RÉF.		10891
Désignation		LUGE TOUPIE
DIM (cm)		Ø64
U.E.		S.10
Rouge	15	
Bleu suédois	66	

LUGES « PELLE »



RÉF.		1004	10893
Désignation		LUGE PELLE	LUGE PELLE
DIM (cm)		49 x 31 x 3	52 x 33,7 x 4
U.E.		S.20	S.10
Coloris assortis			

LUGES DE LOCATION



RÉF.		100300	100400
Désignation		«CARBOSTAR» LUGE DE LOCATION PETIT MODÈLE	«MAXI CARBOSTAR» LUGE DE LOCATION GRAND MODÈLE
DIM (cm)		93 x 45 x 10	111 x 56 x 10
U.E.		S.3	S.3
Rouge	15		

TIRE LUGE







RÉF.		10896
Désignation		TIRE LUGE
DIM (cm)		LONGUEUR 145 CM AVEC CORDELLETTE ET POIGNÉE
U.E.		C.30
Noir	22	



EAN ACCESSOIRES DE DÉNEIGEMENT





RÉF.		10388
Désignation		PELLE PLASTIQUE AVEC RENFORT ALUMINIUM MANCHE ALUMINIUM AVEC GRIP ET POIGNÉE PLASTIQUE
DIM (cm)		40 x 32 x 130
U.E.		B.24 / P.48
Noir		 3 086960 230463

RÉF.		10389
Désignation		PELLE A NEIGE MANCHE TELESCOPIQUE MANCHE ALUMINIUM AVEC GRIP ET POIGNÉE PLASTIQUE
DIM (cm)		25 x H73 à 98 x 6,5
U.E.		C.12 / P.180
Gris		 3 086960 213794

RÉF.		10390
Désignation		PELLE PLASTIQUE MANCHE BOIS Ø28MM LIVRÉE MONTÉE
DIM (cm)		46 x ø2,8 x 145
U.E.		B.16 / P.32
Vert		 3 086960 120436

RÉF.		10391
Désignation		PELLE PLASTIQUE AVEC RENFORT METAL MANCHE BOIS Ø28MM LIVRÉE MONTÉE
DIM (cm)		46 x ø2,8 x 145
U.E.		B.16 / P.32
Gris		 3 086960 176372

RÉF.		10418
Désignation		PELLE ALU ALUMINIUM D'ÉPAISSEUR 2MM MANCHE EN BOIS POIGNÉE PLASTIQUE
DIM (cm)		36 x 45 x 130
U.E.		B.10 / P.60
Gris aluminium		 3 086960 230470



COULEURS

COLORS

FARBEN

COLORES

8 GRIS ANTHRACITE
Anthracite grey.
Anthracite grau.
Antracita

9 VERT GRANNY
Granny green
Granny grün
Verde

15 ROUGE
Red
Rot
Rojo

22 NOIR
Black
Schwarz
Negro

26 VERT
Green
Grün
Verde

29 GRIS ALUMINIUM
Alu grey
Grau Alu
Aluminio

30 GRIS
Grey.
Grau.
Gris

40 BLEU
Blue
Blau
Azul

43 JAUNE
Yellow
Gelb
Amarillo

44 BOIS NATUREL
Natural wood
Naturholz
Madera natural

65 ORANGE
Orange
Orange
Naranja

66 BLEU SUÉDOIS
Suédois
Sweden Blau
Azul turquesa



ETS GEORGES DAVID
36, RUE DES CARMES - CS 10504 - 01117 OYONNAX - CEDEX FRANCE

TÉL. : 00 33 (0)4 74 77 80 44 - FAX : 00 33 (0)4 74 73 84 73
WWW.EDA-PLASTIQUES.COM

