



ESPRIT
JARDIN



EDA



EDITO

La dynamique d'innovation, l'exigence qualité et la responsabilité environnementale permettent à EDA d'être, depuis 1946, un intervenant majeur sur le marché européen des articles en plastique de grande consommation. Nous proposons des solutions pour l'équipement de la maison, du jardin, des loisirs et de l'aménagement extérieur. Avec plus de 70 machines et 83 000 m² de surface de stockage, notre société se révèle comme un partenaire fiable pour l'avenir.

Un futur que nous souhaitons également durable en assumant entièrement notre responsabilité environnementale et sociétale dans tous les aspects de notre travail quotidien. Tous les produits EDA, fabriqués à partir de polyoléfine, sont 100% recyclables.

Parce qu'EDA a mis la fabrication française au cœur de ses priorités en fabriquant ses produits à Oyonnax (Ain 01), site historique depuis plus de 70 ans et essentiellement par des collaborateurs locaux, la marque s'est vue décerner le label Origine France Garantie sur la majorité de ses produits, en reconnaissance de son engagement industriel et gage de la qualité de ses produits.



The dynamics of innovation, quality requirements and environmental responsibility assure to EDA, since 1946, to be a major player on the European market for mass consumption plastic products. We offer solutions for Home, Garden, Leisure and Outdoor.

With over 70 machines and 83 000m² of logistic area, our company is supposed to be a reliable partner for the future. A future we also want sustainable by fully assuming our social and environmental responsibility in all aspects of our daily work. All the products EDA made with polyolefin are 100% recyclable.

Die Erneuerungsdynamik, die Qualitätsforderung und die ökologische Verantwortlichkeit erlauben der Firma EDA PLASTIQUES, seit 1946, ein Hauptbeteiligter im Bereich von Kunststoff Produkten auf dem europäischen Markt zu sein. Wir schlagen Lösungen für Haus – Garten – Freizeit Ausrüstungen und äussere Einrichtungen vor.

Mit mehr als 70 Maschinen und eine Lagerfläche von 83 000 m², stellt unsere Gesellschaft ein zuverlässigen Partner für die Zukunft dar.

Bei Annahme von unserer ökologischen und gesellschaftliche Verantwortlichkeit in jeder Ansicht von unserer täglichen Arbeit, wünschen wir wir dass diese Zukunft dauerhaft bleibt. Alle EDA Produkte hergestellt mit Polyolefin, sind 100% recyclebar.

Una constante innovación, la exigencia de calidad y la responsabilidad del medio ambiente permiten a EDA de ser, desde 1946, un actor principal del mercado europeo sobre la venta de artículos de plástico de gran consumo.

Proponemos soluciones para el equipo del hogar, el jardín, de los ocios así como para el mobiliario y decoración exterior. Con más de 70 máquinas y 83 000 m² de superficie de almacenamiento, nuestra empresa se revela como un socio fiable para el porvenir. Un futuro que deseamos sostenible y durable asumiendo totalmente nuestra responsabilidad con el medio ambiente y sociedad en todos los aspectos de nuestro trabajo diario. Todos los productos EDA fabricados con polyolefina son 100% reciclables.



Créateur, concepteur et fabricant de produits déco pour l'habitat et le jardin, EDA accompagne depuis plus de 70 ans les consommateurs dans l'aménagement de leurs intérieurs et extérieurs. Née à Oyonnax (01), au coeur de la Plastics Vallée, EDA est ainsi devenue une référence incontournable dans l'univers de la décoration.

Nos engagements autour de 7 axes :

- Développer des produits de qualité, durables et recyclables
- Réduire l'impact environnemental de nos produits par l'éco-conception
- Privilégier nos partenaires locaux dans notre politiques d'achats
- Valoriser le savoir-faire et la fabrication française dans nos usines
- Favoriser l'utilisation de matières premières recyclées
- S'engager dans la préservation de la ressource en participant à la gestion durable des forêts
- Participer à la protection de la biodiversité et des écosystèmes avec notre projet Plant Action

Creator, designer and manufacturer of decorative products for home and garden, EDA has been supporting consumers for more than 70 years in the layout of their interiors and exteriors. Born in Oyonnax (01), in the heart of the Plastics Valley, EDA has thus become an essential reference in the world of decoration.

Our commitments around 7 axes :

- . Develop quality, durable and recyclable products
- . Reduce the environmental impact of our products through eco-design
- . Give priority to our local partners in our purchasing policies
- . Promote know-how and French manufacturing in our factories
- . Promote the use of recycled raw materials
- . Engage in the preservation of the resource by participating in the sustainable management of forests
- . Participate in the protection of biodiversity and ecosystems with our Plant Action project

Als Schöpfer, Designer und Hersteller von dekorativen Produkten für Haus und Garten unterstützt EDA die Verbraucher seit mehr als 70 Jahren bei der Gestaltung ihrer Innen- und Außenbereiche. Entstanden in Oyonnax (01), im Herzen des Plastics Valley, ist EDA damit zu einer unverzichtbaren Referenz in der Welt der Dekoration geworden.

Unsere Verpflichtungen rund um 7 Achsen:

- . Entwicklung hochwertiger, langlebiger und recycelbarer Produkte
- . Reduzierung der Umweltauswirkungen unserer Produkte durch Ökodesign
- . Bevorzugung unserer lokalen Partner in unseren Einkaufsrichtlinien
- . Förderung des französischen Know-hows und der Herstellung in unseren Fabriken
- . Förderung der Verwendung von recycelten Rohstoffen
- . Verpflichtung zur Erhaltung der Ressourcen durch Beteiligung an der nachhaltigen Bewirtschaftung der Wälder
- . Beteiligung am Schutz der Biodiversität und der Ökosysteme mit unserem Projekt Plant Action

Creator, diseñador y fabricante de productos decorativos para el hogar y el jardín, EDA acompaña a los consumidores desde hace más de 70 años en el diseño de sus espacios interiores y exteriores. Nacida en Oyonnax (01), en el corazón del Plastic Valley, EDA se ha convertido así en una referencia imprescindible en el mundo de la decoración.

Nuestro compromiso gira en torno a 7 ejes:

- Desarrollar productos de calidad, duraderos y reciclables
- Reducir el impacto ambiental de nuestros productos a través del eco-diseño
- Priorizar a nuestros proveedores locales en nuestras políticas de compras
- Dar valor al saber hacer y a la fabricación francesa en nuestras fábricas
- Promover el uso de materias primas recicladas
- Comprometerse en la preservación de los recursos participando en la gestión sostenible de los bosques
- Participar en la protección de la biodiversidad y los ecosistemas con nuestro proyecto Plant Action



SOMMAIRE

COLLECTION D'INTÉRIEUR & POTERIE DECO	04
<i>INDOOR COLLECTION & POTTERY DECORATION</i>	
<i>INNENKOLLEKTION & TOPFWAREN DEKORATION</i>	
<i>COLECCIÓN INTERIOR & DECORACIÓN DE MACETAS</i>	

AROMATIQUES & POTAGER	32
<i>AROMATICS AND VEGETABLE GARDEN</i>	
<i>KRÄUTER UND GEMÜSEGARTEN</i>	
<i>AROMÁTICOS Y HUERTOS</i>	

AMÉNAGEMENT EXTÉRIEUR	40
<i>OUTDOOR LAYOUT</i>	
<i>ÄUSSERE EINRICHTUNGEN</i>	
<i>MOBILIARIO Y DECORACIÓN EXTERIOR</i>	

GESTION DE L'EAU	50
<i>WATER SYSTEMS</i>	
<i>WASSER VERWALTUNG</i>	
<i>GESTIÓN DE AGUA</i>	

OUTILLAGE & UTILITAIRE	62
<i>GARDEN TOOL</i>	
<i>GARTENGERÄTE</i>	
<i>ACCESORIOS DE JARDÍN</i>	

CHAUFFAGE	72
<i>HEATING</i>	
<i>HEIZUNG</i>	
<i>CALEFACCIÓN</i>	





COLLECTION D'INTÉRIEUR & POTERIE DÉCO

INDOOR COLLECTION & POTTERY DECORATION

INNENKOLLEKTION & TOPFWAREN DEKORATION

COLECCIÓN INTERIOR & DECORACIÓN DE MACETAS



Opale



013305

SPÉCIAL
ORCHIDÉES



013306



013309



013307



013320



013308



APNOR Cert. 74693

OPALE



RÉF.	013305	013306	013307	013308	013309	013320
DIM. LxIxH (CM)	ø12,5 x 15	ø13,7 x 12,6	ø15,5 x 14,2	ø18,5 x 17	ø22 x 20,2	ø29,5 x 27,1
LITRAGE (L)	1,3	1,4	2,1	3,6	6,1	14,8
U.E.	S.5	S.5	S.5	S.5	S.4	S.4





STONE

Diva

NEW



013696



013695

INFORMATIONS TECHNIQUES

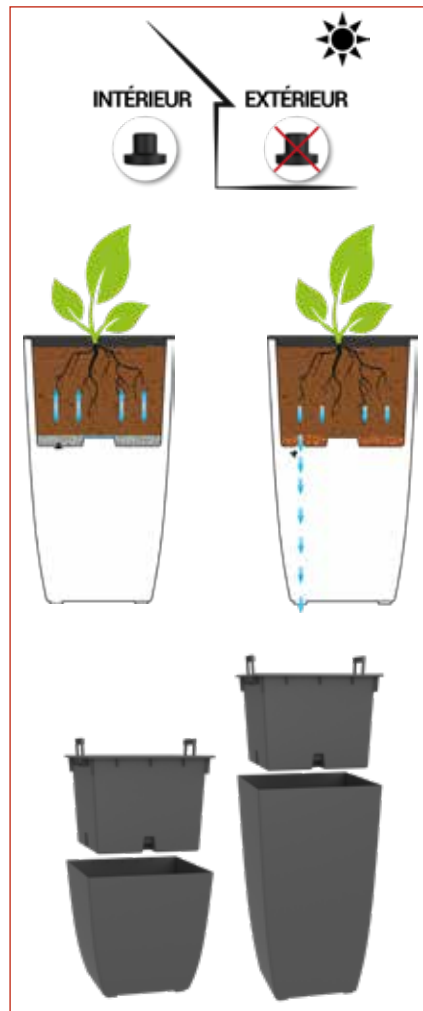

AFNOR Cert. 74693

CARRÉ HAUT DIVA STONE

High square pot Diva Stone
Blumenhalter Diva Stone
Maceta alta Diva Stone



RÉF. 013696

DIM. L x l x H (CM) 43,5 x 43,5 x 78,2

LITRAGE (L) 42

U.E. S.1 / P.8

CARRÉ DIVA STONE

Square pot Diva Stone
Blumenhalter Diva Stone
Maceta cuadrada Diva Stone



RÉF. 013695

DIM. L x l x H (CM) 43,5 x 43,5 x 44,2

LITRAGE (L) 42

U.E. S.2 / P.20





Modulable
Adjustable

VOLCANIA



013730

013731

013739

013732



8

52

BACS ET JARDINIÈRE VOLCANIA DOUBLE PARI, DÉCOR PIERRE

Double wall «Volcania» container and planter, stone decoration
Blumenhalter und Blumenkasten «Volcania» mit doppelten Innenfläche, Stein Dekoration
Maceta y jardinera «Volcania» con doble pared; estilo piedra

RÉF.	013730	013731	013739	013732
DIM. LxI x H (CM)	39,5 x 39,5 x 43,5	99,5 x 39,5 x 43,5	39,5 x 39,5 x 80	99,5 x 39,5 x 60
LITRAGE (L)	31	98	31	116
U.E.	S.1 / P.30	S.1 / P.15	S.1 / P.12	S.1 / P.9



VOLCANIA

LOFT



013744

013746

013728

INFORMATIONS TECHNIQUES

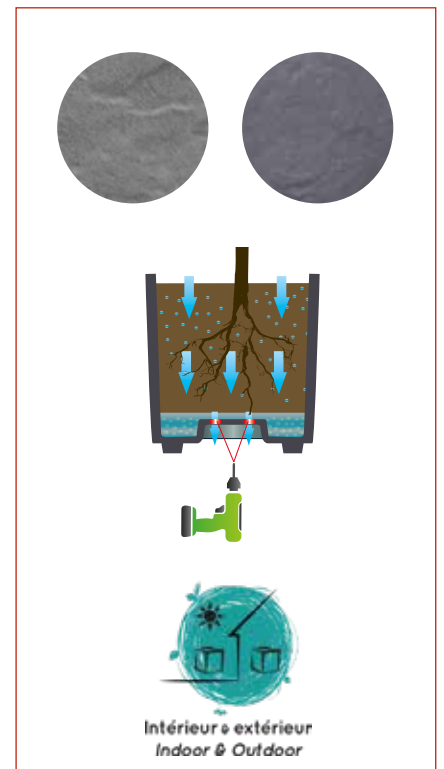

AFNOR Cert. 74693

LOFT VOLCANIA DOUBLE PAROI, DÉCOR PIERRE

Double wall «Volcania» container, stone decoration
Blumenhalter «Volcania»
mit doppelten Innenfläche, Stein Dekoration
Maceta «Volcania» con doble pared; estilo piedra

8 52

RÉF.	013744	013746
DIM. LxI xH (CM)	99,5 x 29,5 x 80	78,5 x 29,5 x 60
LITRAGE (L)	63	46
U.E.	S.1 / P.8	S.1 / P.12

POT CARRÉ VOLCANIA DOUBLE PAROI, DÉCOR PIERRE

Double wall «Volcania» container, stone decoration
Blumenhalter «Volcania»
mit doppelten Innenfläche, Stein Dekoration
Maceta cuadrada «Volcania» con doble pared; estilo piedra

8 52

RÉF.	013728
DIM. LxI xH (CM)	49,5 x 49,5 x 49,5
LITRAGE (L)	57
U.E.	S.1 / P.16



VOLCANIA'UP



013756



013757

013748

INFORMATIONS TECHNIQUES



AFNOR Cert. 74693

JARDINIÈRE VOLCANIA UP

Planter
Blumenkasten
Jardinera



8 52

RÉF. 013756

DIM. L x l x H (CM) 79,5 x 29,5 x 29,5

LITRAGE (L) 57

U.E. S.1 / P.24

CARRÉ VOLCANIA UP

Square pot
Blumenhalter
Maceta cuadrada



8 52

RÉF. 013757

DIM. L x l x H (CM) 29,5 x 29,5 x 29,5

LITRAGE (L) 21

U.E. S.2 / P.48

BALCONNIÈRE VOLCANIA UP

Flowerbox
Blumenkasten
Balconera



8 52

RÉF. 013748

DIM. L x l x H (CM) 59 x 19,5 x 22,8

LITRAGE (L) 25

U.E. S.2 / P.64



013719



013723



013724

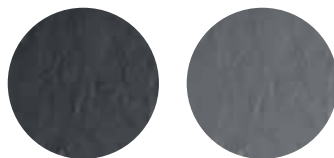

INFORMATIONS TECHNIQUES

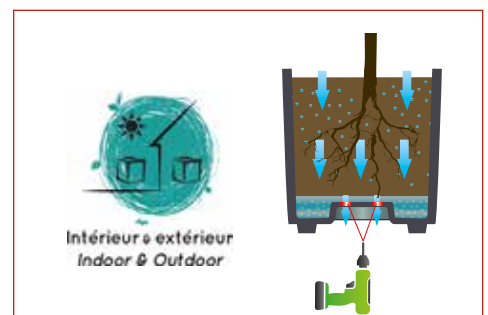

CARRÉ HAUT VOLCANIA UP

High square pot
Blumenhälter
Maceta alta



8 52

RÉF. 013719

DIM. L x l x H (CM) 29,5 x 29,5 x 49,5

LITRAGE (L) 36

U.E. S.1 / P.24

ROND VOLCANIA UP 40CM

Round planter ø40cm
Runden Blumentopf ø40cm
Maceta ø40cm



8 52

RÉF. 013723

DIM. L x l x H (CM) ø38,5 x 36,8

LITRAGE (L) 32,5

U.E. C.2 / P.18

ROND VOLCANIA UP 50CM

Round planter ø50cm
Runden Blumentopf ø50cm
Maceta ø50cm



8 52

RÉF. 013724

DIM. L x l x H (CM) ø48,5 x 46,2

LITRAGE (L) 67

U.E. C.2 / P.8



TOSCANE ROND



013634



013623



013614



013611



013608



013609



013621



013612



013613



013610

INFORMATIONS TECHNIQUES

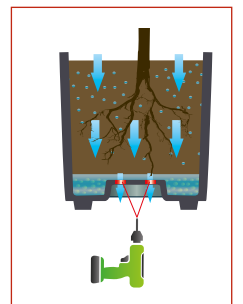

TOSCANE ROND - POTS

Flower vases
Blumentöpfe
Macetas redondas



*Modèles non disponibles en coloris 82

Matière recyclée à partir du ø30cm

RÉF.	013608**	013609**	013621**	013612**	013613
DIM. Ø x H (CM)	13,5 x 11,7	15,3 x 13,7	20 x 17	25 x 21	29,5 x 24
LITRAGE (L)	1,1	1,6	3	6	10
U.E.	S.15	S.15	S.6	S.6	S.6
RÉF.	013610	013611	013614	013623	013634*
DIM. Ø x H (CM)	39,5 x 31	47,5 x 39	59 x 47	79 x 66	98,5 x 79,5
LITRAGE (L)	23	43	76	170	356
U.E.	S.6	S.3	S.3	S.2	S.1

Mini commande par 2



013629



013620



013630



013618



013637



013616

Soucoupes disponibles dans toutes les tailles et coloris



VASES HAUTS

Flower vases
Blumentöpfe
Macetas altas



RÉF.	013629	013630	013637*
DIM. Ø x H (CM)	44 x 53	46 x 65	48,5 x 80
LITRAGE (L)	50	67	90
U.E.	S.3	S.3	S.2

SOUCOUPES

Flower vases
Blumentöpfe
Platillos

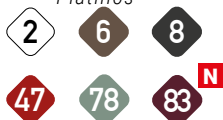

RÉF.	013622	013616	013625	013618	013619	013620	013624
DIM. Ø (CM)	Ø15	Ø18,5	Ø22,5	Ø28	Ø34,5	Ø40,5	Ø 54
POUR POTS	13621	13612	13613	13610	13629 13630 13611 13637	13614	13623
U.E.	S.6	S.6	S.6	S.6	S.3	S.3	S.2

*Modèle non disponible en coloris 82.



TOSCANE CARRÉ



013648



013627



013643



013642



013641

INFORMATIONS TECHNIQUES



Ref. 013642 & 013641



POTS CARRÉS

Square flower pots
Viereckigen Töpfen
Macetas cuadradas



RÉF. 013648 013627 013643

DIM. LxI xH (CM)	49,5 x 49,5 x 52,5	39 x 39 x 39	32 x 32 x 32
LITRAGE (L)	87	38	22
U.E.	S.3	S.3	S.6

POTS CARRÉS À RÉSERVE D'EAU AVEC SOUCOUPES CLIPSÉES

Self watering square flower pots with clipped trays
Viereckigen Töpfen mit Wasserreserve & Unterseizer
Macetas cuadradas con reserva de agua con platos ajustables



RÉF.	013642	013641
DIM. LxI xH (CM)	24,8 x 24,8 x 24,6	17,4 x 17,4 x 17
LITRAGE (L)	10,2	3,4
U.E.	S.6	S.6



INFORMATIONS TECHNIQUES

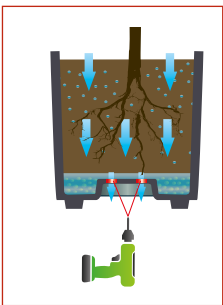

Soucoupes disponibles dans toutes les tailles et coloris



POTS CARRÉS HAUTS
 Square flower pots
 Viereckigen Töpfen
 Macetas altas cuadradas



RÉF.	013628	013635	013639*
DIM. LxI xH (CM)	39 x 39 x 53	39 x 39 x 65	44 x 44 x 80
LITRAGE (L)	51	62	98
U.E.	S.3	S.3	S.2

SOUCOUPES
 Saucers
 Untertassen
 Platlillos



RÉF.	013644	013626	013651
DIM. LxI xH (CM)	26,7 x 26,7 x 3,8	32,6 x 32,6 x 4,9	40 x 40 x 5,9
POUR POT	13643	13627 - 13628 13635 - 13639	13648
U.E.	S.6	S.3	S.3

*Modèles non disponibles en coloris 82.



TOSCANE



013633



013632

013631

REF. 013633

INFORMATIONS TECHNIQUES



Jardinière à réserve d'eau, avec grille filtrante et trop plein
 • Self watering planter, with filtering grating and overflow
 • Gartenplanzer mit Wasserreserve mit Filtergitter und Wasserüberfluss
 • Jardinera con reserva de agua, con rejilla filtrante y exceso de agua



Roulettes bi-directionnelles

INFORMATIONS TECHNIQUES



MURET TOSCANE À RÉSERVE D'EAU AVEC ROULETTES BI-DIRECTIONNELLES

Self watering big planter Toscane
 Gartenplanzer mit Wasserreserve
 Jardinera grande con reserva de agua



RÉF.	013633
DIM. LxIxH (CM)	79 x 35 x 39
LITRAGE (L)	74
U.E.	S.3

JARDINIÈRES TOSCANE ET PLATEAUX CLIPSÉS

Planters with clipped trays
 Blumenkasten mit Untersetzer
 Jardineras con platos ajustables



RÉF.	013631	013632
DIM. LxIxH (CM)	50 x 18 x 16,7	60 x 18 x 16,7
LITRAGE (L)	10	13
U.E.	S.10	S.10



TOSCANE ROND



TOSCANE CARRÉ

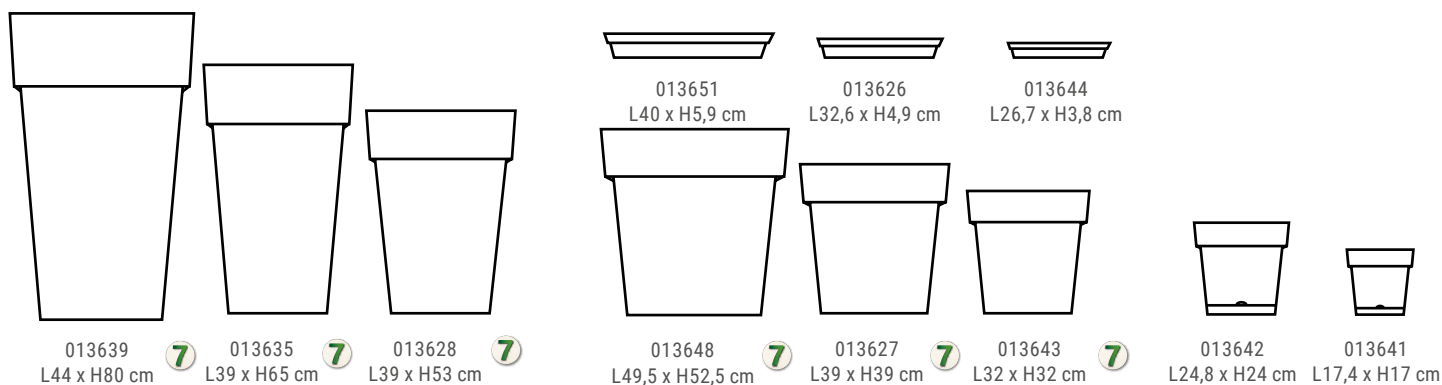

MURET / JARDINIÈRES

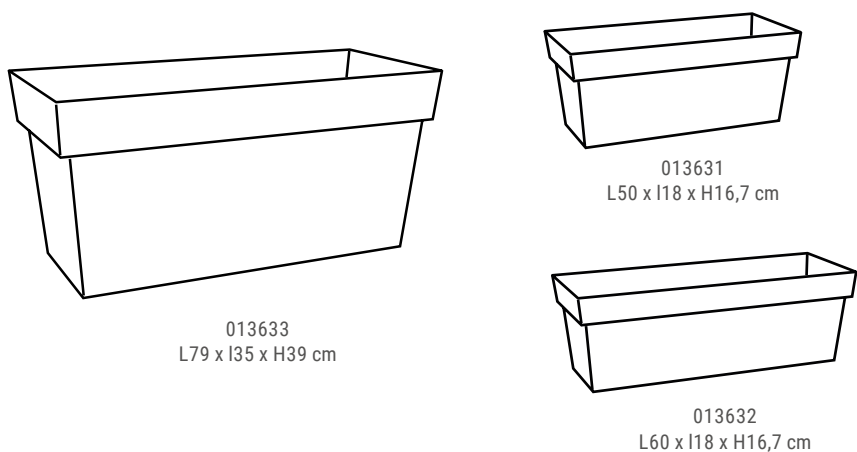



OSAKA

NEW



013584

013583

013582

013581

013580

013577



AFNOR Cert. 74693



POTS OSAKA

Flower vases Osaka
Blumentöpfe Osaka
Macetas Osaka



RÉF.	013584	013583	013582	013581	013580	013577
DIM. Ø x H (CM)	73,6 x 61,8	52 x 42,9	41 x 34,3	30,9 x 25,5	25,6 x 21,2	19,3 x 16
LITRAGE (L)	165	56,8	28,3	11,7	6,5	2,6
U.E.	S. 3	S. 3	S. 6	S. 6	S. 6	S. 6

® Matière recyclée



OSAKA

NEW



018146



018145



019230



019221



019215



SOUCOUPES

Saucer
Untertasse
Platillos

8 78 83

RÉF.	019215	019221	019230	018145	018146
DIM. Ø (CM)	Ø 15	Ø 21	Ø 30	Ø 38	Ø 55
POUR POT	013577	013580 & 013581	013582	013583	013584
U.E.	S.10	S.10	S.10	S.3	S.3

MINIS POTS OSAKA

Flower vases Osaka
Blumentöpfe Osaka
Macetas Osaka

8 78 83

RÉF.	019215	019221	019230	018145	018146
DIM. Ø x H (CM)	Display mini pot «OSAKA» 7,5 cm Ø 7,5 x 6,4 cm		Display mini pot «OSAKA» 10,5 cm Ø 10,5 x 9 cm		
LITRAGE (L)	0,18		0,5		
U.E.	D.60		D.42		
COMPOSITION	30 ● + 15 ● + 15 ●		21 ● + 10 ● + 11 ●		



OSAKA

NEW



013586



013585

INFORMATIONS TECHNIQUES

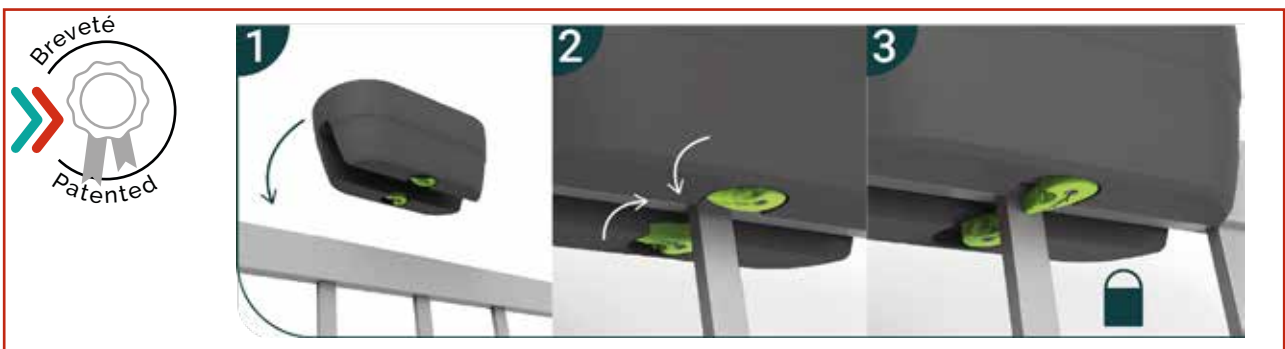

JARDINIÈRE CAVALIÈRE OSAKA



*Straddling planter
Überlappende Blumenkasten
Jardinera*

8	78	83
RÉF.	013586	
DIM. LxIxH (CM)	54,9 x 29 x 20,6	
LITRAGE (L)	19,5	
U.E.	S.6	

POT CAVALIER OSAKA



*Straddling pot
Überlappende Blumentopf
Maceta*

8	78	83
RÉF.	013585	
DIM. Ø x H (CM)	Ø 29 x 20,6	
LITRAGE (L)	8	
U.E.	S.6	

BOX JARDINIÈRES CAVALIÈRES

RÉF.	R015586
DIM. LxIxH (CM)	Jardinière cavalière Cancùn 55 cm 54,9 x 29 x 20,6
LITRAGE (L)	19,5
U.E.	B.42
COMPOSITION	24 ● + 12 ● + 6 ●



NEW

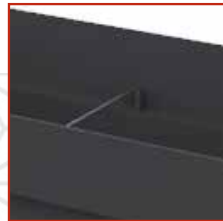

Renfort métallique
 • Metal reinforcement
 • metallische Verstärkung
 • Refuerzo metálico

013588

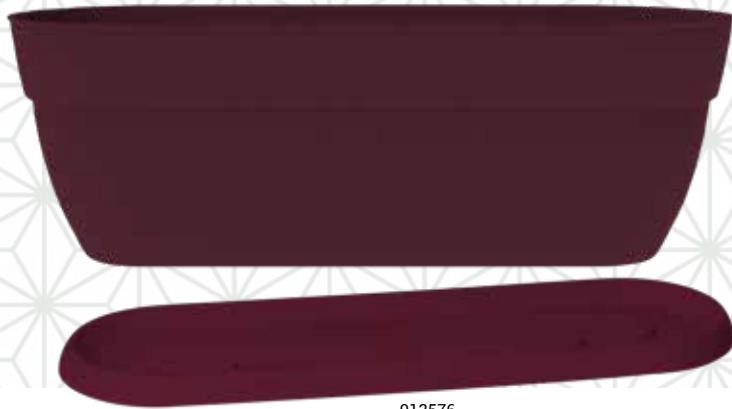

013576



013587



Pieds avec tampon amovible
 • Feet with removable pad
 • Füße mit abnehmbarer Stöpsel
 • Pie con tapón removible



AFNOR Cert. 74693

**JARDINIÈRE
 OSAKA 80CM**

*Planter
 Blumenkasten
 Jardinera*



8 78 83

RÉF. 013588

DIM. LxIxH (CM) 77,3 x 30,7 x 25,9

LITRAGE (L) 38

U.E. S.3

**SOUCOUBE PLATEAU
 OSAKA**

*Saucers
 Untertassen
 Platislos*



8 78 83

RÉF. 013576

DIM. LxIxH (CM) 69,1 x 22 x 2,85

POUR JARDINIÈRE 13588

U.E. S.3

**JARDINIÈRE HAUTE
 OSAKA**

*High planter
 Höhe Blumenkaste
 Jardinera alta*



8 78

RÉF. 013587

DIM. LxIxH (CM) 77,1 x 37,6 x 68

LITRAGE (L) 48

U.E. C.4



CHORUS



* Soucoupes disponibles dans toutes les tailles et coloris



POTS CARRÉS NON PERCÉS CHORUS

*Square non pierced CHORUS pots
Viereckigen Kübel ohne Durchbohrung
Macetas cuadradas sin agujero CHORUS*

RÉF.	013535	013536	013537	013538	013539
DIM. LxI xH (CM)	19,5 x 19,5 x 18,2	24,5 x 24,5 x 22,8	29,5 x 29,5 x 27,3	34,5 x 34,5 x 31,9	40 x 40 x 36,4
LITRAGE (L)	4,3	8,6	15,2	24,2	35,6
U.E.	S.10	S.10	S.10	S.10	S.10



SOUCOUPES CHORUS

*Saucers
Untertassen
Platillos*

RÉF.	013546	013547	013550	013551	013552
DIM. LxI xH (CM)	17,5 x 17,5 x 1,7	22,1 x 22,1 x 1,9	26,8 x 26,8 x 2,3	31,3 x 31,3 x 2,7	36,2 x 36,2 x 3
POUR POTS	13535	13536	13537	13538	13539
U.E.	S.10	S.10	S.10	S.10	S.10





INFORMATIONS
TECHNIQUES



CHORUS



013531



013530



013529



013528



R011455



R011458



R011455



JARDINIÈRES CHORUS ET PLATEAUX CLIPSÉS

Planters «Chorus» with clipped trays
Blumenkasten «Chorus» mit Untersetzer
Jardineras «Chorus» con platos ajustables



RÉF.	013528	013529	013530	013531
DIM. LxIxH (CM)	30 x 12 x 11,4	39,8 x 18,8 x 16,1	48,8 x 18,8 x 16,1	58,8 x 18,8 x 16,1
LITRAGE (L)	2,6	7,5	9,4	11,6
U.E.	S.20	C.20	C.20	C.14

LOTS JARDINIÈRE CHORUS ET PLATEAU CLIPSÉ + SUPPORT INVISIBLE

Set "Chorus" planter + metallic holders
Set Blumenkasten "Chorus" + metallischen Halter
Juego de jardineras "Chorus" + soporte metálico



RÉF.	R011458	R011455
DIM. LxIxH (CM)	30 x 12 x 11,4 + support invisible	48,8 x 18,8 x 16,1 + support invisible
LITRAGE (L)	2,6	9,4
U.E.	C.10	C.10



BOX CHORUS

RÉF.	R011455
DIM. LxIxH (CM)	Jardinière "CHORUS" 50 cm & plateau clipsé + Support invisible 48,8 x 18,8 x 16,1
LITRAGE (L)	9,45
U.E.	B.45
COMPOSITION	23 ● + 22 ●





MARINA



R018140



R018135



R018130



R011457



*



R018125



R018120



R018118



* Soucoupes disponibles dans toutes les tailles et coloris



POTS MARINA

Flower vases
Blumentöpfe
Macetas

6 8 47 53

RÉF.	R018118	R018120	R018125	R018130	R018135	R018140
DIM. Ø x H (CM)	18 x 15,3	20 x 17	25 x 21,5	30 x 25,5	35 x 29,5	40 x 33,7
LITRAGE (L)	2	3	6	10	16	23
U.E.	S.10	S.10	S.10	S.10	S.10	S.10

SOUcoupES MARINA

Saucers
Untertassen
Platillos

6 8 47 53

RÉF.	R019215	R019217	R019221	R019226	R019230	R019234
DIM. Ø (CM)	Ø 15	Ø 17	Ø 21	Ø 26	Ø 30	Ø 34
POUR POTS	R018118	R018120	R018125	R018130	R018135	R018140
U.E.	S.10	S.10	S.10	S.10	S.10	S.10



LOT POT MARINA PERCÉ Ø18 ET SOUCOUPE + SUPPORT MÉTALLIQUE

Set flower pot "Marina" + metallic holder
Set Blumentopf "Marina" + metallischen Hälter
Juego de maceta "Marina" + soporte metálico

RÉF.	R011457
DIM. LxHxH (CM)	Lot 1 pot "MARINA" percé Ø 18 x 15,3 cm + Soucoupe Ø 15 cm + 1 support gris martelé
LITRAGE (L)	2
COMPATIBLE	R018118
U.E.	B.36
COMPOSITION	24 ● + 12 ●

AERIA



R014127

LOTUS



022093



022094



SUPPORT POT BALCON



019184

SUPPORTS MÉTALLIQUES

NEW

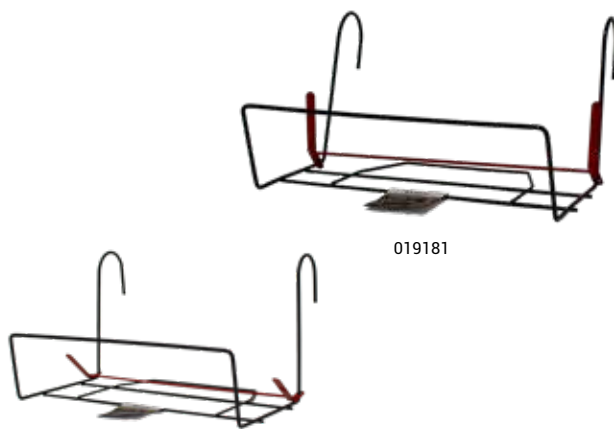

019181

019180

019183



SUSPENSION AERIA AVEC SOUCOUE ET TRINGLE

*Hanging flowers bowls
Aufhängbare Blumenschale
Macetas para colgar*

RÉF. R014127

6

8

DIM. Ø x H (CM) Ø 27 x 47

POUR POTS 4,5

U.E. S.25

COUPE LOTUS AVEC SOUCOUE CLIPSÉE

*Bowl «Lotus» with clipped tray
Pflanzschale «Lotus» mit Unter-setzer
Cuenco «Lotus» con plato ajustable*

6

8

RÉF. 022093 022094

DIM. Ø x H (CM) Ø 25 x 12,6 Ø 30 x 15

LITRAGE (L) 3 5,3

U.E. S.10 S.10

SUPPORT POT BALCON

*Planter support for balcony
Blumentopfhaltung für balkon
Soporte de maceta para balcón*

8

RÉF. 019184 019185

DIM. Ø x H (CM) ø18 ø23

U.E. C.12 C.12

SUPPORTS MÉTALLIQUES

*Holder for planters,
Stütze für Blumenkasten,
Soportes metálicos para jardineras*

8

RÉF. 019180 019181 019182 019183

DIM. L x l x H (CM) 37 x 28 x 20 39 x 30 x 23 48 x 27 x 20 37 x 30 x 21

U.E. C.12 C.12 C.12 C.6



PALMÉA



CHARME



013900

013909



013817

013815

INFORMATIONS TECHNIQUES

BACS ROTOMOULÉS : BACS DOUBLE PAROI À RÉSERVE D'EAU

Self - watering and double wall container
Behälter mit doppelten Innenfläche und Wasserreserve,
Macetas con doble pared y reserva de agua

Bonne isolation et amortit les chocs
• Good insulation and absorb shocks
• Gute Isolierung und Milderung der Stößen
• Buen aislamiento y amortigua los choques

Réserve d'eau : arrosages espacés, économie d'eau
• Self watering : less frequent waterings, water saving
• Wasserreserve : wenige Bewässerungen, Wassergewinn
• Reserva de agua : riegos espaciados, economía de agua

Usage intérieur et extérieur
• Inside and outside
• Für Aussen und Innen Dekoration
• Interior y exterior

Godets

- Bowl,
- Näpfchen,
- Canglion

Trop plein d'eau

- Overflow,
- Wasserüberfluss,
- Exceso de agua



BACS PALMÉA

Containers for shrubs
Blumenkuebel für Busch
Macetas para arbustos



6

30

RÉF. 013900 013901 013909 013904

FORME    

DIM. L x l x H (CM) Ø 70 x 55 sur roulettes 70 x 70 x 55 sur roulettes 47 x 47 x 65 120 x 47 x 42

LITRAGE (L) 98 110 65 124

U.E. V.1 V.1 V.1 V.1

BACS CHARME

Containers
Blumenkuebel
Macetas



31

RÉF. 013810 013815 013816 013817

DIM. L x l x H (CM) 40 x 40 x 40 50 x 50 x 50 100 x 40 x 40 119 x 50 x 50

LITRAGE (L) 31 67 90 155

U.E. V.1 V.1 V.1 V.1

SOUCOUPES A ROULEAUX



010942

60 KG



010943

75 KG

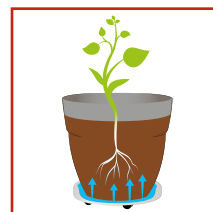

SOUCOUPES À ROULEAUX

Roller saucers
Untertasse mit Rollen
Platillos con ruedecillas

8

RÉF.	010942	010943
DIM. Ø x H (CM)	Ø 34,5 x 5,7 + 4 rouleaux	Ø 45 x 5,7 + 5 rouleaux
U.E.	C.12	C.12

Carton / Display



SUPPORTS À ROULETTES



010941



010940



90941



Roulettes à platine,
multidirectionnelles
• Plate rollers, multidirectional
• Multitenkung Rollen
• Ruedecillas multidireccionales



10937



SUPPORTS À ROULETTES DÉCOR PIERRE
*Flower pot holder with rollers "Stone" decoration,
Gestell mit Rollen für Pflanzentöpfe mit "Stein" Dekoration,
Soporte con ruedecillas aspecto "Piedra"*

RÉF.	010940	010941
DIM. Ø (CM)	Ø 30 - 5 Roulettes	Ø 40 - 6 Roulettes
U.E.	S.4 / C.24	S.4 / C.24

**PRÉSENTOIRS MÉTALLIQUES
POUR SUPPORTS À ROULETTES**

RÉF.	090940	090941
DIM. Ø (CM)	Ø 30	Ø 40
U.E.	1	1

SUPPORT EXTENSIBLE À ROULETTES
*Expandable holder with rollers,
Dehnbare Roller mit Rädchen für Blumentöpfe,
Soporte extensible con ruedecillas*

RÉF.	010937
DIM. Ø x H (CM)	Pour pots carrés ou ronds (de 28,5 à 40,5 cm)
U.E.	C.12

SUPPORTS À ROULETTES



010955



010949



010956



010950

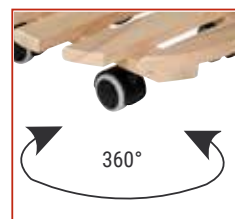

360°

Bois / Wood



SUPPORT À ROULETTES BOIS ROND

Wooden round holder with rollers
Rund Holzstütze mit Rädchen
Soporte de madera redondo con
ruedecillas

RÉF.	010949	010955
DIM. Ø x H (CM)	Ø 30 x 8	Ø 38 x 8,4
U.E.	C.6	C.6

SUPPORT À ROULETTES BOIS CARRÉ

Wooden square holder with rollers
Viereckig Holzstütze mit Rädchen
Soporte de madera cuadrado con
ruedecillas

RÉF.	010950	010956
DIM. L x l x H (CM)	29 x 29 x 8	40 x 40 x 8,4
U.E.	C.6	C.6

PRÉSENTOIR MÉTALLIQUE POUR SUPPORTS À ROULETTES BOIS ROND

RÉF.	R011949	R011955
DIM. L x l x H (CM)	33 x 33 x 160	43,5 x 43,5 x 160
U.E.	1 Présentoir + 3 x C.6	1 Présentoir + 3 x C.6



PRÉSENTOIR MÉTALLIQUE POUR SUPPORTS À ROULETTES BOIS 29x29 ET 40x40 CM

RÉF.	R011950	R011956
DIM. L x l x H (CM)	33 x 33 x 160	43,5 x 43,5 x 160
U.E.	1 Présentoir + 3 x C.6	1 Présentoir + 3 x C.6







AROMATIQUES & POTAGER

*AROMATICS AND VEGETABLE GARDEN
KRÄUTER UND GEMÜSEGARTEN
AROMÁTICOS Y HUERTO*



VEG & Table MAX



013925



R014925



013926



ESPACE POTAGER VEG&TABLE MAX

Garden space "Veg&Table" Max
Pflanztisch "Veg&Table" Max
Mesa de cultivo "Veg&Table" Max



6 8

SERRE DE CULTURE VEG&TABLE MAX

Greenhouse "Veg&Table" Max
Gewächshaus "Veg&Table" Max
Invernadero de cultivo "Veg&Table" Max

2



LOT ESPACE POTAGER
"VEG&TABLE MAX"
+ SERRE DE CULTURE BOX

COMPOSITION

RÉF. 013925

DIM. L x l x H (CM) 75,6 x 55,6 x 68

LITRAGE (L) 85

U.E. C.4

RÉF. 013926

DIM. L x l x H (CM) 74,8 x 54,8 x 26,5

COMPATIBLE 13925

U.E. S.4

RÉF. R014925

U.E. B.14

14 ● + 14 serres



Zone de rétention d'eau
• Water retention area
• Behälter für Wassereinbehaltung
• Zona de retención de agua



Perçage ø8mm pour fixation
• Drilling for fixing
• Durchbohrung für Befestigung
• Taladrado para fijación



VEG&Table CITY



013923



R014208



Aération 2 Positions
 • Ventilation 2 positions
 • 2 belüftungspositionen
 • Aeracion dos posiciones



013924

ESPACE POTAGER VEG&TABLE CITY

Garden space "Veg&Table" City
 Pflanztisch "Veg&Table" City
 Mesa de cultivo "Veg&Table" City

6 8

SERRE DE CULTURE VEG&TABLE CITY

Greenhouse "Veg&Table" City
 Gewächshaus "Veg&Table" City
 Invernadero de cultivo "Veg&Table" City

2

LOT ESPACE POTAGER "VEG&TABLE CITY" + SERRE DE CULTURE BOX



RÉF. 013923

DIM. L x l x H (CM) 76 x 38,5 x 68

LITRAGE (L) 57

U.E. C.4

RÉF. 013924

DIM. L x l x H (CM) 75 x 37,5 x 21,5

COMPATIBLE 13923

U.E. S.4

RÉF. R014198

U.E. B.13

COMPOSITION 13 ● + 13 serres
 ou 13 ● + 13 serres

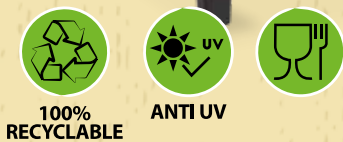

100% RECYCLABLE

ANTI UV



Pieds avec tampon amovible
 • Feet with removable pad
 • Füße mit abnehmbarer Stöpsel
 • Pie con tapón removable



VEG & Table GARDEN



013919



013926



COMPATIBLE
SERRE 013926



8

ESPACE POTAGER VEG&TABLE™ GARDEN

Garden space "Veg&Table" Garden
Pflanztisch "Veg&Table" Garden
Mesa de cultivo "Veg&Table" Garden

RÉF. 013919

DIM. LxIxH (CM) 79 x 59 x 24,5

LITRAGE (L) 67

U.E. S.2 / P.16

SERRE DE CULTURE VEG&TABLE MAX

Greenhouse "Veg&Table" Max,
Gewächshaus "Veg&Table" Max
Invernadero de cultivo "Veg&Table" Max

RÉF. 013926

DIM. LxIxH (CM) 74,8 x 54,8 x 26,5

COMPATIBLE 13925

U.E. S.4

2



VEG&Table AROMATIQUE

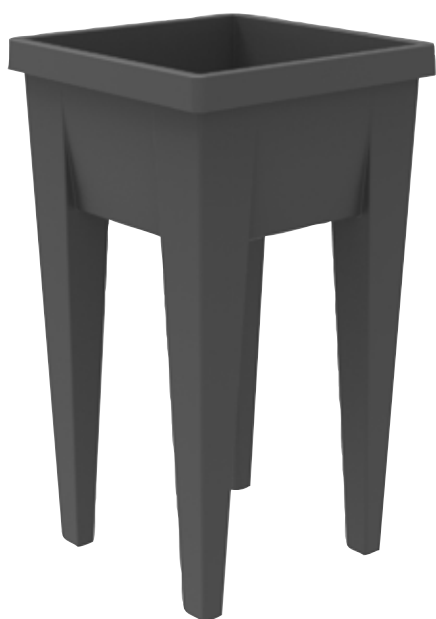

013927



013928



AFNOR Cert. 74693



ESPACE POTAGER VEG&TABLE™ AROMATIQUE

Garden space "Veg&Table" Aromatique
Pflanztisch "Veg&Table" Aromatique
Mesa de cultivo "Veg&Table" Aromatique

6 8

RÉF. 013927

DIM. L x l x H (CM) 38,5 x 38,5 x 68

LITRAGE (L) 23

U.E. C.4

SERRE DE CULTURE VEG&TABLE AROMATIQUE

Greenhouse "Veg&Table" Aromatique
Gewächshaus "Veg&Table" Aromatique
Invernadero de cultivo "Veg&Table" Aromatique

2

RÉF. 013928

DIM. L x l x H (CM) 37,6 x 37 x 21,6

COMPATIBLE 13927

U.E. S.4



100% RECYCLABLE



ANTI UV



Pieds avec tampon amovible

- Feet with removable pad
- Füße mit abnehmbarer Stöpsel
- Pie con tapón removable



VEG & Table *Mini-serres*



013933



013932



MINI-SERRES DE CULTURE

*Mini greenhouses
Mini Gewächshäuser
Mini huerto de cultivo*

6 **8**

RÉF.	013932	013933
DÉTAIL	Taille M	Taille L
DIM. L x l x H (CM)	38 x 25 x 19	56 x 38 x 24
VOLUME (PLATEAU)	5,7	15,7
U.E.	C.4	C.4

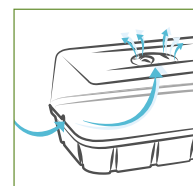

VEG & Table

Tuteur



013947



2 en 1



NEW

PIÈGE À GUÊPES



022185

LIVRÉ À PLAT
Flat pack
Flach geliefert
Se suministra en plano

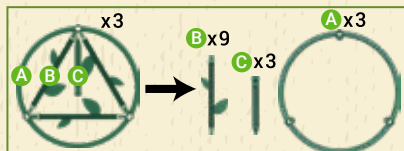

PIQUET - FACILE A PLANTER
Pole - easy to plant
Stab - leicht zum pflanzen
Poste - fácil de plantar



DÉCLIPSABLE
Removable
Abnehmbar
Extraíble

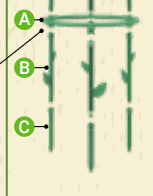
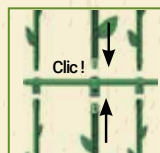

TAPETTE À MOUCHES



022186



TUTEUR
Plant support
Pflanzenstütze
Soporte de planta

21

RÉF. 013947

DIM. Ø X H (CM) 025 x 66,3

U.E. C.12

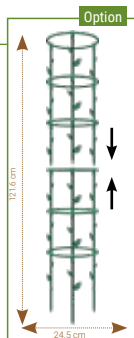

x2

OPTION POSSIBLE
Possible option
Verschiedene Option
Opción posible



PIÈGE À GUÊPES N
Wasp trap
Wespenfalle
Trampa para avispas

1

RÉF. 022185

DIM. L x H (CM) 18,5 x 18 x 15

U.E. C.10



TAPETTE À MOUCHES N
Fly swatter
Fliegenklatsche
Matamoscas

85

RÉF. 022186

DIM. L x H (CM) 47 x 10 x 1

U.E. C.50



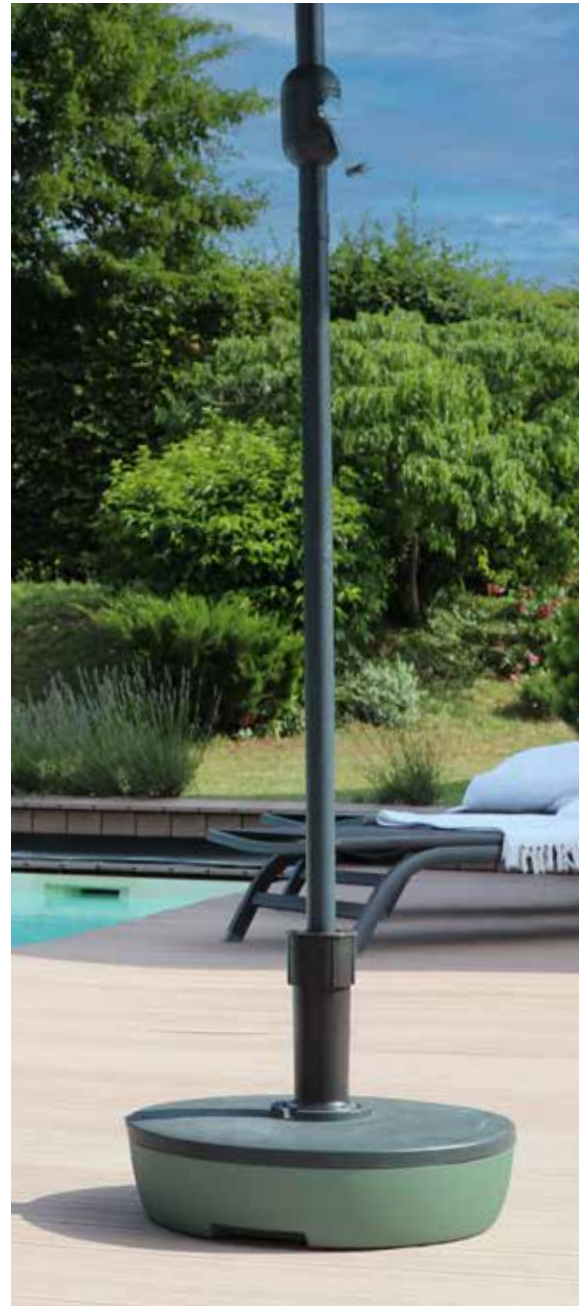

AMÉNAGEMENT EXTÉRIEUR

OUTDOOR LAYOUT

ÄUSSERA EINRICHTUNGEN

MOBILIARIO Y DECORACIÓN EXTERIOR



BAYA

INFORMATIONS TECHNIQUES



Cadenassable
Lockable
Verschliessbar
Cierre con candado



Anti étouffement
Anti-suffocation
Anti-Erstickung
Anti ahogo

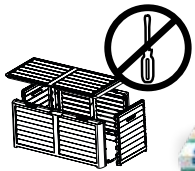

010290



010291



MALLE 420L

Outdoor Box
Aussenkoffer
Arcón de Jardín



6

8

RÉF. 010290

DIM. LxIxH (CM) 117,3 x 54,8 x 65,3

LITRAGE (L) 420

U.E. P.5 / P.13

COFFRES

Boxes
Koffer
Arcónes



8

RÉF. 010292 010291

DIM. LxIxH (CM) 72,5 x 54,5 x 54,5 97,5 x 54,7 x 58

LITRAGE (L) 160 250

U.E. S.2 / P.16 P.8 / P.14



SERENA



INFORMATIONS TECHNIQUES



MALLES

Outdoor boxes
Aussenkoffer
Arcones de jardín



	010191	010194
REF.	010191	010194
DIM. L x L x H (CM)	121 x 55 x 66 avec roulettes	121 x 76 x 67 avec roulettes
LITRAGE (L)	310	500
U.E.	P.8	P.6

Roulettes
Rollers
Rädchen
Ruedas



Cadenassable
Lockable
Verschliessbar
Cierre con candado

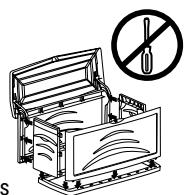

Anti étouffement
Anti-suffocation
Anti-Erstickung
Anti ahogo

Anti-pincement de doigts
Anti-finger pinching
Anti-Fingersklemmen
Antipellizco de dedos





DALLES CLIPSABLES

NEW



010902

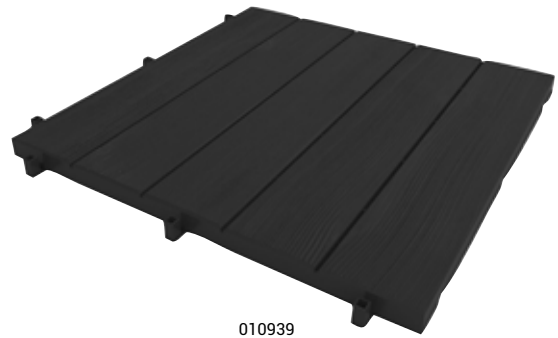

010939

INFORMATIONS TECHNIQUES

1m² ≈ 6x



Anti dérapant
Non-skid
Rutschfest
Anti resbalante



Résistance au chlore
Resistance to chlorine
Chlorfestigkeit
Resistencia al cloro



Lavage eau et savon
Cleaning with water and soap
Reinigung Wasser + Seife
Se lava con agua y jabón

INFORMATIONS TECHNIQUES

1m² ≈ 4x



Anti dérapant
Non-skid
Rutschfest
Anti resbalante



Résistance au chlore
Resistance to chlorine
Chlorfestigkeit
Resistencia al cloro



Lavage eau et savon
Cleaning with water and soap
Reinigung Wasser + Seife
Se lava con agua y jabón

DALLES CLIPSABLES DÉCOR BOIS

Paving plastic in imitation of wood,
Bodenplatte aus Kunststoff - Holz Imitation,
Losa de plástico imitación madera



RÉF. 010902 010939 **N**

DIM. LxIxH (CM) 39,5 x 39,5 x 2,5 49,5 x 49,5 x 2,5

U.E. C.36 / P.198 F.8 / P.288

COULEUR **6** **22** **22**

Deux poses

Two installations
Zwei Posen
Dos poses

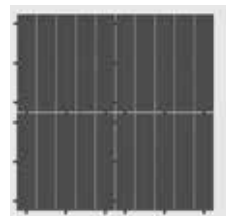



PIEDS DE PARASOL À REMPLIR

NEW



019636

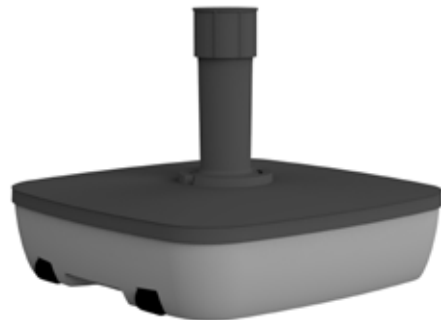

019637

INFORMATIONS TECHNIQUES



INFORMATIONS TECHNIQUES



PIEDS DE PARASOL

Parasol bases
Sonnenschirmständer
Pies de parasol

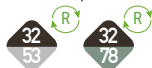

RÉF.

019636

DIM. LxLxH (CM)

ø49,5 x 14,5
sans tige montée

POIDS (KG)

+/- 20kg avec de l'eau / +/- 32kg avec du sable

ØMAT (CM)

3,2 à 5

U.E.

S.4

PIEDS DE PARASOL

Parasol bases
Sonnenschirmständer
Pies de parasol



RÉF.

019637

DIM. LxLxH (CM)

49,5 x 49,5 x 14,5
sans tige montée

POIDS (KG)

+/- 25kg avec de l'eau / +/- 40kg avec du sable

ØMAT (CM)

3,2 à 5

U.E.

S.4



AFNOR Cert. 74693



PIEDS DE PARASOL PLASTIQUE

INFORMATIONS TECHNIQUES



Ø 1,8 à 3,2 cm

13 kg

18 kg *



INFORMATIONS TECHNIQUES



Ø 1,8 à 3,2 cm

14 kg

19 kg *



INFORMATIONS TECHNIQUES



Ø 3,8 à 5,6 cm

40 kg

52 kg *



PIEDS DE PARASOL PLASTIQUE

Plastic parasol bases
Sonnenschirmständer aus Kunststoff
Pies de parasol de plástico



	ROND		CARRÉ	
RÉF.	010703	019703	010704	010607
DIM. L x l x H (CM)	ø43 x 28	ø43 x 28	42 x 42 x 28,5	56,5 x 56,5 x 31,5
Ø MAT (CM)	1,8 à 3,2	1,8 à 3,2	1,8 à 3,2	3,8 à 5,6
U.E.	S.6 / P.60	C.16	S.10 / P.60	S.4 / P.20
COULEUR	2 32	2 32	2	2 32

* Le poids du pied rempli de sable est donné à titre indicatif et est sujet à d'importantes variations suivant la qualité du sable. The indicative weight of the parasol base filled with sand, may vary depending on the sand quality. Das Gewicht vom Schirmständer mit Sand gefüllt ist nur zur Information angegeben und kann sich verändert je nach der Sandqualität. El peso de la base rellena de arena esta comunicado de manera indicativa. Importantes varaciones pueden ser constatadas según la calidad de la arena utilizada.

PIEDS DE PARASOL BÉTON



019646



019646

Ø 1,8 à 3,3 cm



019649

Ø 3,2 à 5 cm

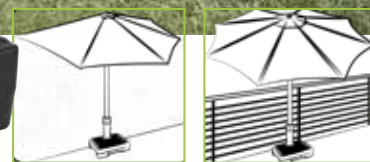

019702

Ø 3,2 à 5 cm



019644

Ø 3,2 à 5 cm



27 KG

019651

Ø 3,2 à 5 cm

Roulettes amovibles



019650

30 KG



PIEDS DE PARASOL BÉTON

Cement parasol bases
Sonnenschirmständer mit Beton
Base de parasol en hormigón

RÉF.	019646	019649	019702	019644	019651	019650
DIM. L x l x H (CM)	Ø 38 x 25	39,4 x 29,3 x 34	43,5 x 43,5 x 34	Ø 48,5 x 31	Ø 48,5 x 31	48,5 x 48,5 x 31
POIDS (KG)	14	20	25	27	27	30
Ø MAT (CM)	1,8 à 3,3	3,2 à 5	3,2 à 5	3,2 à 5	3,2 à 5	3,2 à 5
ROULETTES					x	x
U.E.	P.36	P.16	P.24	P.16	P.16	P.16
COULEUR	2 32	32	2 32	32	32	32



INFORMATIONS TECHNIQUES

LESTS

PRÊT À L'EMPLOI

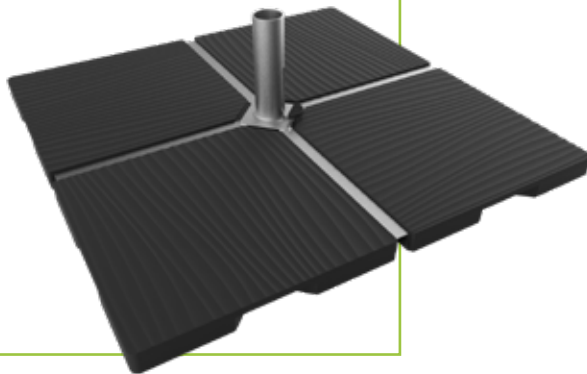

019633

INFORMATIONS TECHNIQUES

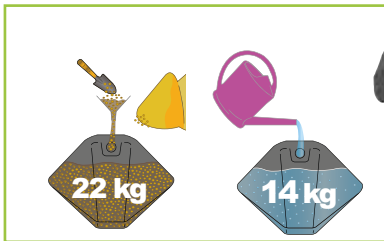

019680



019632



LEST BÉTON 22KG
Cement ballast 22 kg
Ballast Beton 22 kg
Lastre de cemento 22 kg



LEST À REMPLIR POUR MÂT DÉPORTÉ
Ballast to fill for overhanging parasols
Ballast zum füllen für Pendelschirme
Base de parasol rellenable para mastil deportado



LEST BÉTON DÉCOR PIERRE 18 KG POUR MÂT DÉPORTÉ

Concrete ballast "stone" decoration 18kg for overhanging parasols
Beton Ballast «Stein Dekoration» 18 kg für Pendelschirme
Lastre de hormigón imitación piedra para mastil deportado



RÉF.	019633
DIM. LxIxH (CM)	49,5 x 49,5 x 5
POIDS (KG)	22
U.E.	P.28

RÉF.	019680
DIM. LxIxH (CM)	49 x 49 x 8,7
U.E.	S.4 / P.60

RÉF.	019632
DIM. LxIxH (CM)	49 x 49 x 5,2
POIDS (KG)	18
U.E.	P.20

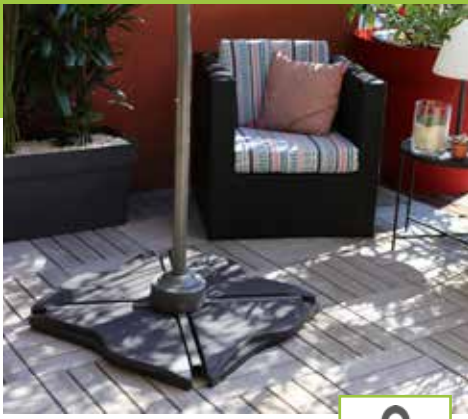

48 KG

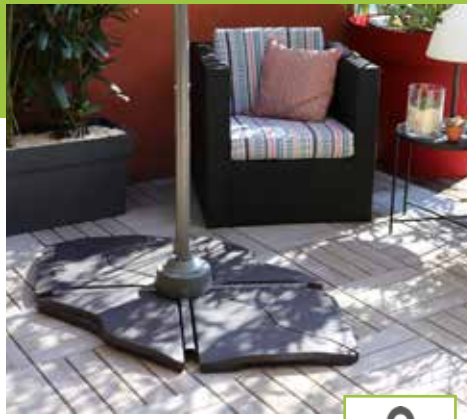

72 KG

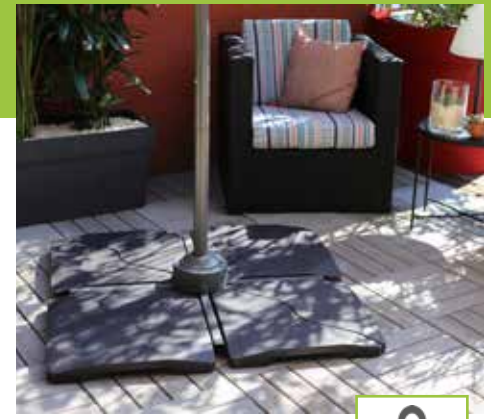

96 KG



19634

INFORMATIONS TECHNIQUES

PRÊT À L'EMPLOI

MODULABLE

PIEDS DE TONNELLE

Ø 2 à 3,5 cm

14 KG

010706

INFORMATIONS TECHNIQUES

Ø 2 à 3,2 cm

8 kg 11 kg *

010705



LEST BÉTON TRIANGULAIRE 12KG
 Triangular cement ballast 12 kg
 Dreieckigen Ballast Beton 12 kg
 Lastre cemento triangular 12kg

32

RÉF.	019634
DIM. LxIxH (CM)	48 x 48 x 5,8
POIDS (KG)	12
U.E.	P.32

PIED DE TONNELLE BÉTON 14 KG
 Cement gazebo base
 Pavillonständer mit Beton
 Pie de cenador hormigón

2

RÉF.	010706
DIM. LxIxH (CM)	20,5 x 19 x 34
POIDS (KG)	14
Ø MAT (CM)	2 à 3,5
U.E.	P.36

PIED DE TONNELLE PLASTIQUE
 Plastic gazebo base
 Pavillonständer
 Pie de cenador plastico

2

RÉF.	010705
DIM. ØxH (CM)	24 x 25,5
POIDS (KG)	8 - 11
Ø MAT (CM)	2 à 3,2
U.E.	S.4

* Le poids du pied rempli de sable est donné à titre indicatif et est sujet à d'importantes variations suivant la qualité du sable. The indicative weight of the parasol base filled with sand, may vary depending on the sand quality. Das Gewicht vom Schirmstand mit Sand gefüllt ist nur zur Information angegeben und kann sich verändert je nach der Sandqualität. El peso de la base rellena de arena esta comunicado de manera indicativa. Importantes variaciones pueden ser constatadas según la calidad de la arena utilizada.





GESTION DE L'EAU

*WATER SYSTEMS
WASSER VERWALTUNG
GESTIÓN DE AGUA*



ARROSOIRS D'INTÉRIEUR



010756



013271



010619



022178

022177



022180



022181



Long-lasting brass nozzle
Buse en laiton robuste et réglable
Langlebige Messingdüse

**ARROSOIR LONG
BEC ESCARGOT 3L**
*Extended spout watering can
Giesskanne mit langer Tülle
Regadera pico largo*

56	RÉF.	010756
DIM. LxIxH (CM)	56 x 12 x 23	
LITRAGE (L)	3	
U.E.	S.12	

PULVÉRISATEUR 1L
*Spray
Blumensprüher
Pulverizador*

8	RÉF.	010619
DIM. LxIxH (CM)	12,5 x 9,2 x 26	
LITRAGE (L)	1	
U.E.	C.12	

VAPORISATEUR EMMA N
*Spray Emma
Blumensprüher Emma
Pulverizador Emma*

84	79	RÉF.	022177
DIM. LxIxH (CM)	14 x 14 x 26		
LITRAGE (L)	1		
U.E.	S.8		

ARROSOIR EMMA N
*Watering can Emma
Giesskanne Emma
Regaderas Emma*

6	84	RÉF.	022178
DIM. LxIxH (CM)	52 x 14 x 26,5		
LITRAGE (L)	2,5		
U.E.	S.8		

ARROSOIR LONG BEC 2L
*Extended spout watering can
Giesskanne mit langer Tülle
Regaderas pico largo*

56	RÉF.	013271
DIM. LxIxH (CM)	48 x 12 x 23	
LITRAGE (L)	2	
U.E.	S.8	

ARROSOIR FUCHSIA N
*Watering can Fuchsia
Giesskanne Fuchsia
Regaderas Fuchsia*

Coloris transparents / Transparent colours / Transparente
Farben / Colores transparentes



Coloris fumés / Smoky colours / Rauchige Farben /
Colores ahumados



RÉF.	022180
DIM. LxIxH (CM)	32 x 11,5 x 17
LITRAGE (L)	1,5
U.E.	C.4

VAPORISATEUR FUCHSIA N
*Spray Fuchsia
Blumensprüher Fuchsia
Pulverizador Fuchsia*

Coloris transparents / Transparent colours / Transparente
Farben / Colores transparentes



Coloris fumés / Smoky colours / Rauchige Farben /
Colores ahumados



RÉF.	022181
DIM. LxIxH (CM)	11 x 7,5 x 25,5
LITRAGE (L)	1
U.E.	C.12



ARROSOIRS



010600



019600

019583



019552

019658



**ARROSOIRS OVALES
PARISIENS AVEC POMME**
*Oval watering can with rose
Oval Giesskanne mit Brause
Regadera ovalada con alcachofa*

56

RÉF.	010600	010583
DIM. LxIxH (CM)	42 x 12 x 27	48 x 15 x 34,5
LITRAGE (L)	3	6
U.E.	S.10	S.10

ARROSOIRS OVALES PARISIENS AVEC POMME
*Watering cans with rose
Oval Giesskanne mit Brause,
Regaderas ovaladas con alcachofa*

27

RÉF.	019600	019583
DIM. LxIxH (CM)	42 x 12 x 27	52 x 14,5 x 34
LITRAGE (L)	3	6
U.E.	S.10	S.10

ARROSOIRS PROMOS AVEC POMME
*Watering cans with rose
Oval Giesskanne mit Brause,
Regaderas ovaladas con alcachofa*

27^R

RÉF.	019552	019658
DIM. LxIxH (CM)	60 x 18,5 x 40	57 x 18 x 38,5
LITRAGE (L)	11	11
U.E.	S.6 / B.52	S.6



ARROSOIRS



ARROSOIRS OVALES LUXE AVEC POMME

Watering cans with rose
Oval Giesskanne mit Brause
Regaderas ovaladas con alcachofa

27 ^R	RÉF.	010737	010848
DIM. LxIxH (CM)		65 x 22 x 41	73 x 19,5 x 45
LITRAGE (L)		12	15
U.E.		S.5	S.4

ARROSOIR EXTRA FORT AVEC POMME

Extra strong watering can with rose
Extra Starke Giesskanne mit Brause
Regadera extra fuerte con alcachofa

8 ^R	RÉF.	013201
DIM. LxIxH (CM)		57 x 19 x 44
LITRAGE (L)		13
U.E.		S.5

ARROSOIRS RONDS LYONNAIS

Watering cans
Oval Giesskanne
Regaderas ovaladas

27 ^R	RÉF.	019630	019541
DIM. LxIxH (CM)		45 x 16,5 x 33	55 x 19,5 x 44
LITRAGE (L)		6	11
U.E.		S.10	S.5

POMMES D'ARROSOIRS

Roses
Brause
Alcachofas

22 ^R	RÉF.	013002	013003	013004	013005
DIM. ØxH (CM)		8,5 x 10	10,5 x 12,5	12,5 x 14,5	12,5 x 14,5
LITRAGE (L)		3	6	11 / 14	12 / 13 / 15
U.E.		20	20	20	20

RAMPE D'ARROSAGE

Watering spray head,
Regnerleiste,
Rampa de riego

21	RÉF.	010614
DIM. LxIxH (CM)		5 à 50
U.E.		C.12

Récup'O 300L

NEW



010985



Marquage de la zone de perçage pour connexion accessoires - Emplacement pour fixation au mur

- Marking of the drilling area for accessories connection - Location for fixing to the wall
- Markierung von der Bohrungszone für Verbindung von Zubehörteilen - Schlitz für Wandbefestigung
- Zona de perforación para conexión de accesorios señalada - Ranura para fijación mural



Bouchon trappe de "sécurité" Ø 170 mm

- Security hatch plug Ø 170 mm
- Sicherheit Stau Klappe Ø 170 mm
- Tapón de seguridad Ø 170 mm

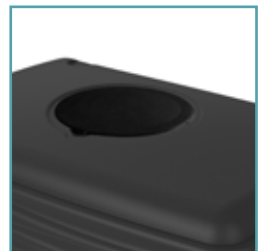

Robinet à embout pour raccord du tuyau d'arrosage - livré non monté

Bouchon de vidange - livré monté

- Tap valve for garden hose connection - delivered not assembled

Drain plug - delivered assembled

- Gekipptes Ventil für Gartenschlauchanschluss - nicht montiert

Angeliefert mit montierten Ablaufstopfen

- Grifo para la conexión de manguera de jardín - Entregado no montado

Tapón de evacuación - entregado montado



RÉCUP'O 300L
Rainwater tank
Regentonnen
Depósito de agua



RÉF. 010985

DIM. L x l x H (CM) 60 x 40 x 137

LITRAGE (L) 300

U.E. P.4



RÉCUP'DÉCO



INFORMATIONS TECHNIQUES

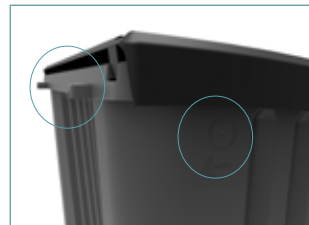

Marquage de la zone de perçage pour connexion accessoires - Pattes de décalage pour fixation au mur

- Marking of the drilling area for accessories connection - Offset brackets for fixing to the wall
- Markierung von der Bohrungszone für Verbindung von Zubehörteilen - Versetzte Halterungen für Wandbefestigung
- Zona de perforación para conexión de accesorios señalada - Patas de desvío para fijación mural



Cadenassable

- Lockable
- Verschlussbar
- Cierre con candado



Maintien en position ouverte du couvercle pour une utilisation pratique et facile

- Keeping the lid open for convenient and easy use
- Deckel in Offenstellung für eine praktische und einfache Verwendung
- Mantenimiento en posición abierta de la tapa para un uso cómodo y fácil

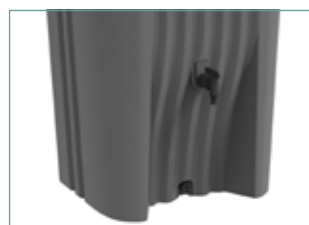

Robinet - livré non monté

Bouchon de vidange - livré monté

- Tap - delivered not assembled
- Drain plug - delivered assembled
- Mit Hahn angeliefert - nicht montiert
- Angeliefert mit montierten Ablaufstopfen
- Grifo - Entregado no montado
- Tapón de evacuación - entregado montado



RÉCUP'DÉCO

Rainwater tank
Regentonnen
Déposito de agua



RÉF. 010963

DIM. LxIxH (CM) 59,4 x 50,3 x 101,3

LITRAGE (L) 150

U.E. P.16

RÉCUP'ÉCO

310L



010964



Cuve murale, réalisée en soufflage

- Wall tank, blow molded
- Gespritzter Wandtank
- Depósito de pared fabricado en sopladura

Bouchon trappe de "sécurité" Ø 170 mm

- Security hatch plug Ø 170 mm
- Sicherheit Stau Klappe Ø 170 mm
- Tapón de seguridad Ø 170 mm

Robinet, livré non monté

- Tap delivered non assembled
- Hahn geliefert nicht montiert
- Grifo enviado, no instalado

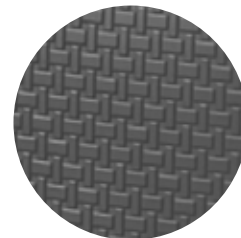
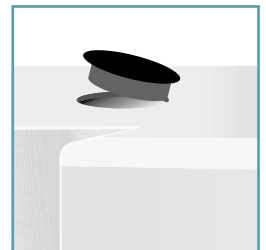
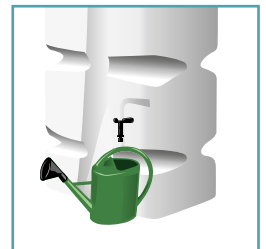

INCLUS !



AFNOR Cert. 74693

RÉCUP'ÉCO
DÉCOR TRESSÉ
 Rainwater tank
 Regentonnen
 Depósito de agua



8

28

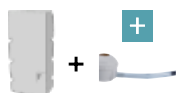

RÉF. 010964

DIM. LxIxH (CM) 60 x 40 x 138

LITRAGE (L) 310

U.E. P.4





NEW

RÉCUP'O



250L

500L

010962

010983

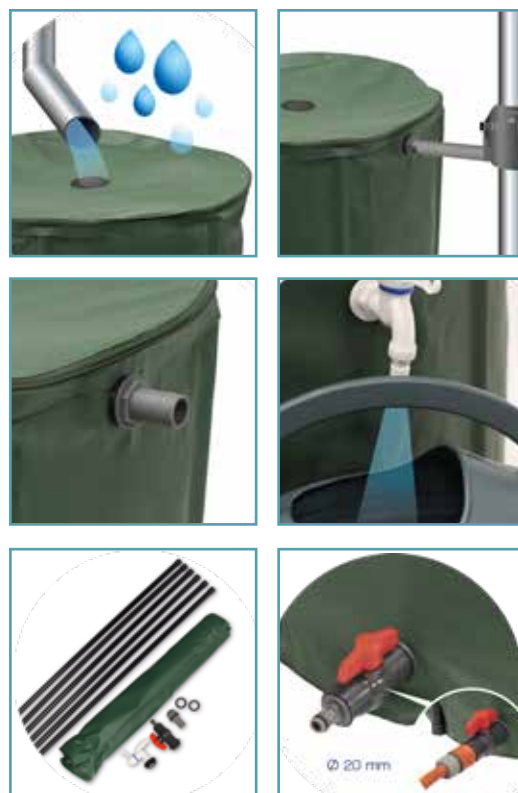

RÉCUP'O SOUPLE ET PLIABLE

250 ET 500L

Rainwater tank
Regentonnen
Deposito de agua



21

	RÉF. 010962	010983
DIM. Ø x H (CM)	60 x 88	80 x 98
LITRAGE (L)	250	500
U.E.	C.6	C.4



RÉCUP'O

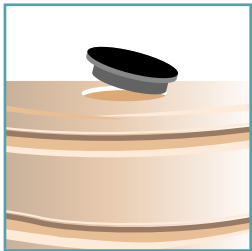

INCLUS !



350L

OU

550L

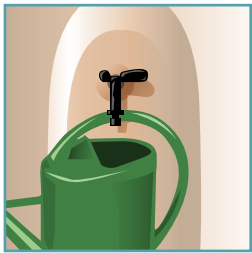

Cuves murales, réalisées en soufflage formes "ovoïdes"
 • Wall tanks, blow molded - ovoid shapes
 • Gespritzter Wandtank "Eiförmige" Form
 • Depósitos fabricados en sopladura - forma "huevo"

Bouchon trappe de "sécurité" Ø 170 mm
 • Security hatch plug Ø 170 mm
 • Sicherheit Stau Klappe Ø 170 mm
 • Tapón de seguridad Ø 170 mm

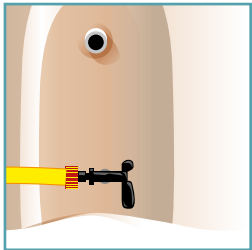

Robinet à embout pour raccord au tuyau d'arrosage, livrés montés
 • Tap with connecting tip for water garden hose, delivered assembled
 • Hahn mit Anschluss für Garten Schlauch, montiert geliefert
 • Grifo con contera para conexión al manga de riego, entregados montados

Bouchon de vidange
 • Drain plug
 • Abflussverschluss
 • Tapón de vaciado



010919



RÉCUP'O

350 ET 550L

Rainwater tank
 Regentonnen
 Depósito de agua

RÉF.	010919	010908
DIM. L x l x H (CM)	65 x 50 x 144	79 x 56 x 164
LITRAGE (L)	350	550
U.E.	P.4	P.2
COULEUR	8	8



RÉCUPÉRATEURS D'EAU

1000L

INCLUS!

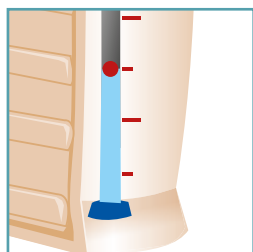
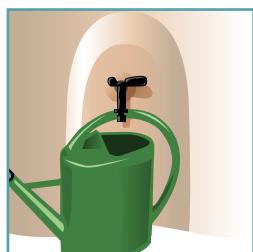
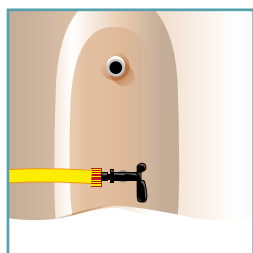
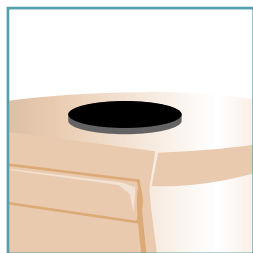

500L



010914



010910

Cuves réalisées en rotomoulage

- Rotation molded tanks
- Geschleuderte Tanks

• Cubas fabricadas en rotomoldeado

Cuves murales, dos plats et renforcés

- Wall hanging tanks, with flat and reinforced back
- Wandtanks mit flachen und verstärkten Rückseiten
- Depósitos de pared, respaldos planos y reforzados

Niveau d'eau avec jauge (bille flottante)

- Water level with gauge (floating ball)
- Einer Kanalwaage mit ausgestattete Eichmass (schwimmende Murmel)
- Nivel de agua con barómetro (bola flotante)

Bouchon de vidange + robinet à embout pour raccord au tuyau d'arrosage, livrés montés sur inserts métalliques

- Drain plug + tap with connecting tip for water garden hose, delivered assembled on metallic inserts
- Abflussverschluss + Hahn mit Anschluss für Garten Schlauch, montiert geliefert auf metallischen Einsätzen

Tapón de vaciado + grifo con contera para conexión al manga de riego, entregados montados sobre insertos metálicos.

RÉCUP'O

500L ET 1000L

Rainwater tank
Regentonnen
Depósito de agua



28

RÉF.	010914	010910
DIM. L x l x H (CM)	80 x 64 x 152	107 x 80 x 181
LITRAGE (L)	500	1 000
U.E.	P.2	P.1



AFNOR Cert. 74693



ACCESSOIRES ET COLLECTEURS



10916

INFORMATIONS TECHNIQUES

Compatible avec tous les modèles de récupérateurs d'eau, de toutes les formes

- Adaptable to all models of rainwater tanks of every shapes
- Geeignet für alle Regentonne Modelle
- Compatible con todos los modelos de depósitos de agua, de todas las formas

Adaptable à toutes les gouttières carrées ou rondes, d'un diamètre compris entre 65 et 100 mm

- Adaptable to all square or round rain pipes, with diameter between 65 and 100 mm
- Geeignet für runden oder viereckigen Fallrohre zwischen 65 bis 100 mm
- Adaptable a todos los canalones cuadrados o redondos, de un diámetro incluido entre 65 y 100mm

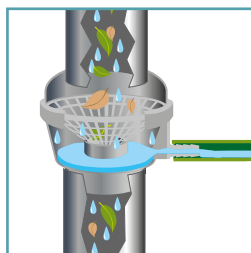

10947

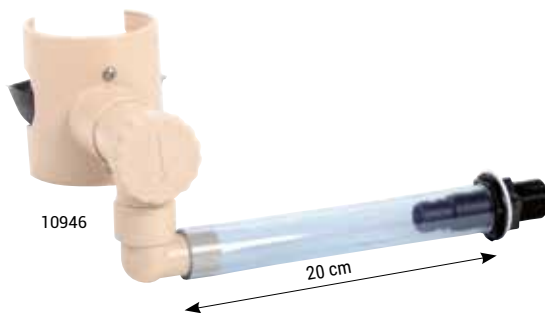

10946

20 cm

INFORMATIONS TECHNIQUES



Installation facile, perçage de la gouttière avec une

scie-cloche fournie

Easy to install, gutter drilling with a hole saw provided

Leichte Montage, Durchbohrung vom Fallrohr mit

Sägeglocke inbegriffen

Instalacion facil, perforacion del canal con la sierra per-

foradora suministrada.

Compatible avec tous les modèles de récupérateurs d'eau

• Adaptable to all models of rainwater tanks of every

shapes

• Geeignet für alle Regentonne Modelle

• Compatible con todos los modelos de depósitos de agua,

de todas las formas



401917

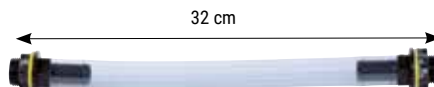

32 cm

10915

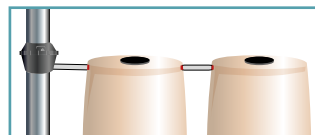

KIT COLLECTEUR FILTRANT UNIVERSEL

Universal filtering collector kit
Universaler Regensammler
Kit colector filtrante universal

30

RÉF. 010916

U.E. S.10

ROBINET 3/4 GAZ

22

RÉF. 401917

U.E. S.10

KIT COLLECTEUR PRÉMIUM CAPT'EAU

Kit collector
Regensammler
Kit colector

RÉF. 010946 010947

DIM. L x l x H (CM) Rond - pour gouttière Ø 8 à 10 cm Carré - pour gouttière 8 à 10 cm

U.E. C.6 C.6

COULEUR 30 28 28

KIT DE JUMELAGE UNIVERSEL

Universal twinning kit
Universaler Verbindungsset
Kit de emparejamiento universal

1

RÉF. 010915

DIM. Ø x H (CM) 32

U.E. S.10





OUTILLAGE & UTILITAIRE

*GARDEN TOOL
GARTENGERÄTE
ACCESORIOS DE JARDÍN*



OUTILLAGE



010334



010526



013119



019726



019546



BROUETTE DE JARDIN LIVRÉE MONTÉE

Garden wheelbarrow totally assembled
Garten Schubkarre - Geliefert voll montiert
Carretilla de jardín - entregada montada

6^R

RÉF.	010334
DIM. LxIxH (CM)	111 x 60 x 68,5
LITRAGE (L)	140
U.E.	P.10

PANIER DE JARDIN FLEXIBLE GRADUÉ

Flexible garden basket
Biegsamer gartenkorb
Cesta de jardín flexible

26

RÉF.	010526
DIM. ØxH (CM)	46 x 37
LITRAGE (L)	43
U.E.	S.10

SEAU À COMPOST

Compost bucket
Komposteimer
Cubo para compostación

8^R 75

RÉF.	013119
DIM. LxIxH (CM)	24,8 x 23,8 x 24,3
LITRAGE (L)	6
U.E.	C.6

PANIER DE RAMASSAGE AVEC ANSE

Gathering baskets with handle
Sammelkörbe mit Griff
Cestas con asa

RÉF.	019546	019726
DIM. LxIxH (CM)	50 x 34,5 x 16	52 x 35 x 18
LITRAGE (L)	13	18
U.E.	S.10	S.10
COULEUR	21 ^R	21 ^R 56 ^R 8 ^R



SACS DE RAMASSAGE

POP UP !



35 KG

010531

INFORMATIONS TECHNIQUES

REF. 010531

WATER PROOF



25 KG

010530

SACS DE RAMASSAGE

Collection bags
Sammelbeutel
Sacos de recogida

RÉF.	010531	010530
------	--------	--------

DIM. Ø x H (CM)	50 x 60	50 x 72
-----------------	---------	---------

LITRAGE (L)	117	141
-------------	-----	-----

U.E.	C.12	C.12
------	------	------

21



OUTILLAGE



010389



010391



010388



010390



010418

PELLE PLASTIQUE MANCHE EN ALUMINIUM AVEC GRIP ET POIGNEE RENFORT ALU

22

Plastic shovel with aluminum handle with grip
With aluminium reinforcement on shovel
Schaufel aus kunststoff mit aluminum griff
Mit aluminium verstärkung auf der schaufel
Pala de plastico con mango de aluminio y puñal
Renfuerzo de aluminio en la pala

RÉF. 010388

DIM. LxIxH (CM) 40 x 32 x 130

U.E. B.24

PELLES DE RAMASSAGE OU DE DÉNEIGEMENT

Snow shovel
Schneeschaufel
Pala quitanieve

RÉF. 010390 010391

DIM. LxIxH (CM) 145 x 46 145 x 46

U.E. B.16 B.16

COLORIS

21

30

PELLE ALU MANCHE EN BOIS. POIGNEE EN PLASTIQUE

29

Aluminium shovel with wooden handle and plastic grip
Aluminium 2mm thickness high
Quality aluminium schaufel mit holz stiel griff aus kunststoff
Hochwertiges aluminium 2mm stärke
Pala de aluminio con mango de madera Puñal de plástico
Aluminio 2mm de alta calidad

RÉF. 010418

DIM. LxIxH (CM) 36 x 45 x 130

U.E. B.10

PELLE A NEIGE A MANCHE TELESCOPIQUE

Telescopic snow shovel
Ausziehbare schnee schaufel
Pala quitanieve telescópica

30

RÉF. 010389

DIM. LxIxH (CM) 25 x H 77 à 97 cm

U.E. C.12

BAQUETS, SEAUX RURAUX ET AGRICOLES



BAQUETS RONDS

Tubs
Kübel
Cubetas



RÉF.	019522	019525	019534	019926
DIM. ØxH (CM)	58 x 52 x 26,5	63 x 56 x 32	69,5 x 61 x 39	80 x 70 x 46
LITRAGE (L)	30	50	75	110
U.E.	F.15	F.10	F.5	F.5

BAQUETS OVALES

Tubs
Kübel
Cubetas



RÉF.	019528	019752
DIM. LxØxH (CM)	65 x 50 x 30	80 x 58 x 33
LITRAGE (L)	50	70
U.E.	F.10	F.5

SEAUX AGRICOLES

Buckets
Einer
Cubos



RÉF.	019591	019592	019593
DIM. ØxH (CM)	28 x 24,5	32 x 27	33 x 29
LITRAGE (L)	10	13	16
U.E.	S.10	S.10	S.10

SEAUX À VENDANGE ET SEAUX À VEAUX

Vintage bucket and veal bucket
Eimer für weinlese
Cubo de vendimia con asa de madera y de metal

RÉF.	059523	010523
DIM. LxØxH (CM)	35 x 22,5	35 x 22,5
LITRAGE (L)	15,5	15,5
U.E.	S.25	S.25
COULEUR		

POUBELLES D'EXTÉRIEUR / VOIRIE



010633



INFORMATIONS TECHNIQUES



013001

079558



060556



060557



013011



010618

050621

013012

POUBELLES D'EXTÉRIEUR / VOIRIE

*Outdoors dustbins
Mülleimer für draussen
Cubos de basura de exterior*

POUBELLE À ROULETTES 110L



RÉF. 010633

DIM. L x l x H (CM) 55 x 58 x 81

LITRAGE (L) 110

U.E. S.2 / Pal.16

POUBELLES IMMEUBLE AVEC COUVERCLES PLATS



RÉF. 079557 079558 013001

DIM. L x l x H (CM) 54 x 48 x 49,5 61 x 54,5 x 56 57 x 52 x 65

LITRAGE (L) 50 80 80

U.E. F.5 F.5 / Pal. 60 Pal. 60

CORPS DE POUBELLE IMMEUBLE



RÉF. 060556 060557 013011

DIM. L x l x H (CM) 46,5 x 38,5 x 38 51,5 x 48 x 44 63 x 55 x 49

LITRAGE (L) 30 50 75

U.E. F.10 F.5 F.8

COUVERCLES DE POUBELLE



RÉF. 010618 050621 013012

DIM. L x l x H (CM) 43,5 x 40,5 x 5,5 52 x 48 x 8 61 x 57 x 9,5

LITRAGE (L) 30L - 60556 50L - 60557 75L - 13011

U.E. F.5 F.5 F.8



POUBELLE D'EXTÉRIEUR



010644

INFORMATIONS TECHNIQUES

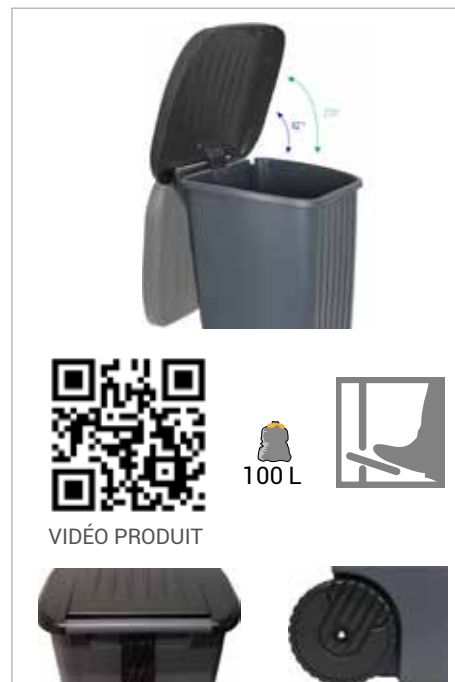

POUBELLE D'EXTÉRIEUR 100L

*Outdoors dustbins
Mülleimer für draussen
Cubos de basura de exterior*



RÉF.	010644
DIM. LxH (CM)	50 x 48,6 x 83,5
LITRAGE (L)	100
U.E.	S.4

JERRICANS



010585

010587

010586



010510

010161

010162



010987



010559

010558



010542



AFNOR Cert. 74693

JERRICANS ALIMENTAIRES EXTRA FORT, BOUCHON SIMPLE, ROBINET

Jerrycans extra strong, simple stopper with tap
 Kanister extra stark, einfachverschluss + hahn
 Bidón extra fuerte con tapón simple y grifo



RÉF.	010584	010585	010586	010587
DIM. LxIxH (CM)	23,5 x 11 x 30	29 x 15 x 35	32 x 16 x 38	39 x 17 x 44
LITRAGE (L)	5	10	15	20
U.E.	S.15	S.10	S.10	S.5

JERRICANS ALIMENTAIRES

Jerrycans with pouring stopper
 Kanister mit giessverschluss
 Bidones con tapón vertedor



RÉF.	010510	010161	010162
DIM. LxIxH (CM)	23,5 x 11 x 30	32,1 x 17,8 x 30,1	35 x 23 x 36,5
LITRAGE (L)	5	10	20
	Verseur	Verseur	Verseur
U.E.	S.20	S.10	S.5

JERRICAN SPECIAL CARAVANE

Jerrycan special caravan with tap
 Kanister spezial wohnwagen mit grosser
 offnung für pumpe und hahn
 Bidón especial caravana con abertura
 grande para bomba y grifo



RÉF.	010987
DIM. LxIxH (CM)	39,5 x 24 x 47,5
LITRAGE (L)	35
U.E.	S.6

JERRICAN PLIABLE + ROBINET

Foldable jerrycan
 Faltbarer kanister
 Bidón plegable



RÉF.	010542
DIM. LxIxH (CM)	25 x 25 x 25 (6 cm plié)
LITRAGE (L)	15
U.E.	C.12

FÛTS MULTI-USAGES 100% HERMÉTIQUE

Barrel multi-uses 100% watertight
 Fass multi Verwendung 100% Wasserdicht
 Tonel multiuso



RÉF.	010558	010559
DIM. LxIxH (CM)	29 x 29 x 46	36 x 36 x 53
LITRAGE (L)	25	50
U.E.	S.4	S.3

JERRICANS

INFORMATIONS TECHNIQUES



Homologué transport produits dangereux (Norme UN)



010177



010662



010176



010167



010168



019553



010169

INFORMATIONS TECHNIQUES



Homologué transport produits dangereux (Norme UN)



INFORMATIONS TECHNIQUES



Homologué transport produits dangereux (Norme UN)



19162

JERRICANS MÉTALLIQUES HOMOLOGUÉS HYDROCARBURES

Approved metal jerrycans for petrol (un norm) - pouring
Geprüfte kanister geeignet für benzin transporte (normen un)
- Giessverschluss mit hoher sicherheit
Garrafas homologadas para transporte de gasolina (normas un)
- Tapa vertidora con alta seguridad

50

RÉF.	010176	010167	010168	010177
DIM. LxIxH (CM)	24,7 x 10,6 x 27,5	28,2 x 13 x 39	34,5 x 16,5 x 46,8	Bec verseur
LITRAGE (L)	5	10	20	-
U.E.	C.5	C.5	C.5	S.5



AFNOR Cert. 74693

BIDON À MAZOUT

Drums for fuel 111 With filter
Ölkanne 11l mit filter
Bidon para fuel 11l con filtro



RÉF. 010662

DIM. LxIxH (CM) 65 x 20 x 31,5

LITRAGE (L) 11

U.E. S.6

JERRICANS PLASTIQUES "PROMO"

Jerrycans "promo" with rigid pouring stopper inside jerrycans
"Promo" kanister mit steifen giessverschluss Im kanister
Garrafas "promo" con bico vertedor rígido encajado en la garrafa

42

RÉF.	019553	019554	019555
DIM. LxIxH (CM)	23,5 x 11 x 30	29 x 15 x 36	37,5 x 17 x 45
LITRAGE (L)	5	10	20
U.E.	S.20	S.10	S.5

JERRICAN DOUBLE COMPARTIMENT HOMOLOGUÉ HYDROCARBURES

Approved twin jerrycan for hydrocarbur - rigid pouring stopper
Kanister mit doppelten abteilen geprüft für schierstoffe - mit steifen giessverschluss
Garrafa con doble compartimento para hidrocarburo - bico vertedor rígido

14

RÉF.	010169
DIM. LxIxH (CM)	31,8 x 16,7 x 31,4
LITRAGE (L)	6 + 2,5
U.E.	S.6



AFNOR Cert. 74693

JERRICANS PLASTIQUES HOMOLOGUÉS HYDROCARBURES

Approved jerrycans for hydrocarbur - rigid pouring stopper inside jerrycans
Geprüfte kanister für schmierstoffe - mit steifen giessverschluss im kanister
Garrafas para transporte de gasolina (normas un) - tapa vertidor con alta seguridad

15

RÉF.	019160	019161	019162
DIM. LxIxH (CM)	32,1 x 17,8 x 18,2	32,1 x 17,8 x 30,1	35 x 23 x 36,5
LITRAGE (L)	5	10	20
U.E.	S.10	S.10	S.5



AFNOR Cert. 74693

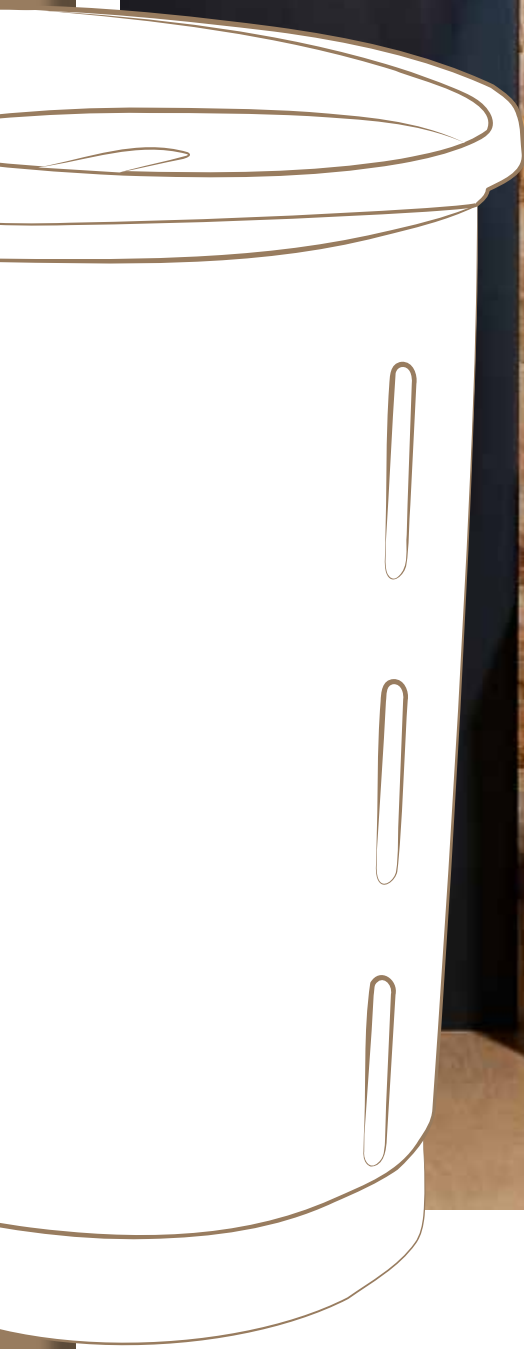

*Jura
Montania*
BY EDA





CHAUFFAGE

HEATING

HEIZUNG

CALEFACCIÓN



PELLES ET SACS À GRANULÉS



010479



010483

INFORMATIONS TECHNIQUES



010488



010487



PELLES À GRANULÉS

Wood pellet shovel
Pelletschaufel
Pala para pellets de madera

	22 ^R	
RÉF.	010479	010483
DIM. LxIxH (CM)	11,8 x 15,8 x 18,2	19,3 x 16,5 x 21,9
LITRAGE (L)	1	2,4
CONTENANCE PELLETS (KG)	0,7	1,5
U.E.	D.12	D.20

SACS À GRANULÉS

Wood pellet bag
Pelletsäcke
Bolsas de pellets

	22 ^R	
RÉF.	010488	010487
DIM. ØxH (CM)	ø44 x 45	40 x 40 x 40
LITRAGE (L)	60	60
CONTENANCE PELLETS (KG)	30	40
U.E.	C.12	C.12



COFFRES À GRANULÉS



010481



010478



010482

INFORMATIONS TECHNIQUES

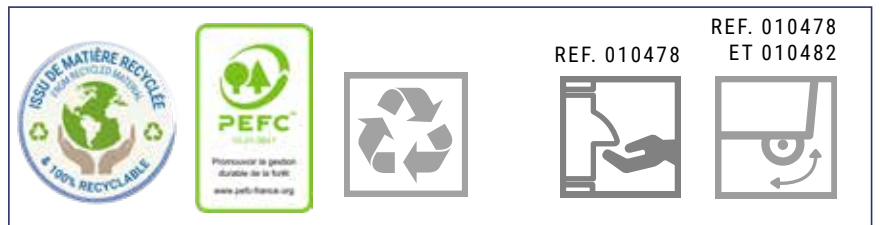

REF. 010478
REF. 010478
ET 010482

CARRÉ STONE



RÉF. 010481

DIM. LxIxH (CM)	29,5 x 29,5 x 50,6
LITRAGE (L)	36
CONTENANCE PELLETS (KG)	20
U.E.	S.4

COFFRE À GRANULÉS

Wood pellet box
Pelletbak met deksel
Baúl para pellets de madera



RÉF. 010478

DIM. ØxH (CM)	ø 39,7 x 60,5
LITRAGE (L)	38
CONTENANCE PELLETS (KG)	25
U.E.	S.5

COFFRE À GRANULÉS XL

Wood pellet box
Pelletbak met deksel
Baúl para pellets de madera



RÉF. 010482

DIM. LxIxH (CM)	49,5 x 37,9 x 66,4
LITRAGE (L)	70
CONTENANCE PELLETS (KG)	45
U.E.	S.4



AFNOR Cert. 74693

EAN COLLECTION D'INTÉRIEUR ET POTERIE DÉCO



Opale



RÉF.	013305	013306	013307	013308	013309	013320
Désignation	CACHE-POT « OPALE » Ø12,5 CM	CACHE-POT « OPALE » Ø13,7 CM	CACHE-POT « OPALE » Ø15,5 CM	CACHE-POT « OPALE » Ø18,5 CM	CACHE-POT « OPALE » Ø22 CM	CACHE-POT « OPALE » Ø29,5 CM
DIM (cm) Litrage (L)	ø 12,5 x 15 1,3	ø 13,7 x 12,8 1,4	ø 15,5 x 14,2 2,1	ø 18,5 x 17 3,6	ø 22 x 20,2 6,1	ø 29,5 x 27,1 14,8
U.E.	S.5	S.5	S.5	S.5	S.4	S.4
Noir	 3 086960 264895	 3 086960 265366	 3 086960 265403	 3 086960 265441	 3 086960 265489	 3 086960 265526
Blanc ivoire	 3 086960 264901	 3 086960 265373	 3 086960 265410	 3 086960 265458	 3 086960 265496	 3 086960 265533
Bleu profond	 3 086960 265342	 3 086960 265380	 3 086960 265427	 3 086960 265465	 3 086960 265502	 3 086960 265540
Nude	 3 086960 265359	 3 086960 265397	 3 086960 265434	 3 086960 265472	 3 086960 265519	 3 086960 265557

STONE ^N Diva



RÉF.	013696	013695
Désignation	CARRÉ DIVA STON	CARRÉ HAUT DIVA STONE
DIM (cm) Litrage (L)	43,5 x 43,5 x 78,2 42	43,5 x 43,5 x 44,2 42
U.E.	S.1 / P.8	S.2 / P.20
Noir	 3 086960 273422	 3 086960 273439

GAMME VOLCANIA



RÉF.	013730	013728	013731	013739	013732
Désignation	POT CARRÉ VOLCANIA 40 CM DOUBLE PAROI - AVEC ZONE DE RÉTENTION D'EAU	POT CARRÉ VOLCANIA 50 CM DOUBLE PAROI - AVEC ZONE DE RÉTENTION D'EAU	JARDINIÈRE VOLCANIA DOUBLE PAROI - AVEC ZONE DE RÉTENTION D'EAU	BAC CARRÉ HAUT VOLCANIA DOUBLE PAROI - AVEC ZONE DE RÉTENTION D'EAU	MURET VOLCANIA DOUBLE PAROI - AVEC ZONE DE RÉTENTION D'EAU
DIM (cm) Litrage (L)	39,5 x 39,5 x 43,5 31	49,5 x 49,5 x 49,5 57	99,5 x 39,5 x 43,5 98	39,5 x 39,5 x 80 31	99,5 x 39,5 x 60 116
U.E.	S.1 / P.30	S.1 / P.16	S.1 / P.15	S.1 / P.12	S.1 / P.9
Gris Anthracite	 3 086960 223700	 3 086960 253134	 3 086960 223724	 3 086960 241919	 3 086960 235222
Gris Galet	 3 086960 241667	 3 086960 253141	 3 086960 241698	 3 086960 241926	 3 086960 241681

GAMME VOLCANIA



RÉF.	013746	013744
Désignation	LOFT L VOLCANIA DOUBLE PAROI - AVEC ZONE DE RÉTENTION D'EAU	LOFT XL VOLCANIA DOUBLE PAROI - AVEC ZONE DE RÉTENTION D'EAU
DIM (cm) Litrage (L)	78,5 x 29,5 x 60 46	99,5 x 29,5 x 80 63
U.E.	S.1 / P.12	S.1 / P.8
Gris Anthracite	 3 086960 253073	 3 086960 249380
Gris Galet	 3 086960 253080	 3 086960 249403

VOLCANIA UP



RÉF.	013723	013724
Désignation	ROND 40 CM VOLCANIA UP AVEC ZONE DE RÉTENTION D'EAU	ROND 50 CM VOLCANIA UP AVEC ZONE DE RÉTENTION D'EAU
DIM (cm) Litrage (L)	ø38,5 x 36,8 32,5	ø48,5 x 46,2 67
U.E.	C.2	C.2
Gris Anthracite	 3 086960 259617	 3 086960 259990
Gris Galet	 3 086960 259983	 3 086960 260002

VOLCANIA UP



RÉF.	013748	013757	013756	013719
Désignation	BALCONNIÈRE VOLCANIA UP AVEC ZONE DE RÉTENTION D'EAU	CARRÉ VOLCANIA UP AVEC ZONE DE RÉTENTION D'EAU	JARDINIÈRE VOLCANIA UP AVEC ZONE DE RÉTENTION D'EAU	CARRÉ HAUT VOLCANIA UP AVEC ZONE DE RÉTENTION D'EAU
DIM (cm) Litrage (L)	59 x 19,5 x 22,8 25	29,5 x 29,5 x 29,5 21	79,5 x 29,5 x 29,5 57	29,5 x 29,5 x 49,5 36
U.E.	S.2 / P.64	S.2 / P.48	S.1 / P.24	S.1 / P.24
Gris Anthracite	 3 086960 253165	 3 086960 253202	 3 086960 253240	 3 086960 263676
Gris Galet	 3 086960 253172	 3 086960 253219	 3 086960 253257	 3 086960 263683

POTS ROUNDS TOSCANE



RÉF.	013608	013609	013621	013612	013613
Désignation	POT TOSCANE Ø14 CM	POT TOSCANE Ø15 CM	POT TOSCANE Ø20 CM	POT TOSCANE Ø25 CM	POT TOSCANE Ø30 CM
DIM (cm) Litrage (L)	Ø 13,5 x 11,7 1,1	Ø 15,3 x 13,7 1,6	Ø 20 x 17 3	Ø 25 x 21 6	Ø 29,5 x 24 10
U.E.	S.15	S.15	S.6	S.6	S.6
Gris Anthracite	 3 086960 232665	 3 086960 232757	 3 086960 217365	 3 086960 212537	 3 086960 203900
Taupe	 3 086960 232672	 3 086960 232764	 3 086960 217341	 3 086960 212513	 3 086960 205348
Rouge rubis	 3 086960 236168	 3 086960 236175	 3 086960 236199	 3 086960 236090	 3 086960 236052
Bourgogne	 3 086960 273521	 3 086960 273538	 3 086960 273545	 3 086960 273552	 3 086960 273569
Vert laurier	 3 086960 263805	 3 086960 263812	 3 086960 263829	 3 086960 263836	 3 086960 263843
Blanc	 3 086960 232610	 3 086960 232726	 3 086960 230685	 3 086960 230821	 3 086960 204358

EAN COLLECTION D'INTÉRIEUR ET POTERIE DÉCO



RÉF.	013610	013611	013614	013623	013634
Désignation	POT TOSCANE Ø40 CM GARANTIE 5 ANS FRANCE MÉTROPOLITAINE	POT TOSCANE Ø50 CM GARANTIE 5 ANS FRANCE MÉTROPOLITAINE	POT TOSCANE Ø60 CM GARANTIE 5 ANS FRANCE MÉTROPOLITAINE	POT TOSCANE Ø80 CM GARANTIE 5 ANS FRANCE MÉTROPOLITAINE	POT TOSCANE Ø100 CM GARANTIE 5 ANS FRANCE MÉTROPOLITAINE
DIM (cm) Litrage (L)	Ø 39,5 x 31 23	Ø 47,5 x 39 43	Ø 59 x 47 76	Ø 79 x 66 170	Ø 98,5 x 79,5 356
U.E.	S.6	S.3	S.3	S.2	S.1 * Minimum commande par 2
Gris Anthracite	 3 086960 203948	 3 086960 204310	 3 086960 207489	 3 086960 216405	 3 086960 223434
Taupe	 3 086960 206376	 3 086960 206383	 3 086960 209230	 3 086960 216429	 3 086960 233532
Rouge rubis	 3 086960 236038	 3 086960 236045	 3 086960 236083	 3 086960 236212	 3 086960 236281
Bourgogne	 3 086960 273576	 3 086960 273583	 3 086960 273590	 3 086960 273606	
Vert laurier	 3 086960 263850	 3 086960 263317	 3 086960 263324	 3 086960 272784	 3 086960 272791
Blanc	 3 086960 204303	 3 086960 204327	 3 086960 207472	 3 086960 225285	 3 086960 230623

SOUCOUPES POUR POTS RONDS TOSCANE



RÉF.	013622	013616	013625	013618	013619
Désignation	SOUCOUCPE TOSCANE POUR POT Ø 20 CM	SOUCOUCPE TOSCANE POUR POT Ø 25 CM	SOUCOUCPE TOSCANE POUR POT Ø 30 CM	SOUCOUCPE TOSCANE POUR POT Ø 40 CM	SOUCOUCPE TOSCANE POUR POT Ø 48 CM
DIM (cm) POUR POTS	Ø 15 13621	Ø 18,5 13612	Ø 22,5 13613	Ø 28 13610	Ø 34,5 13629 / 13630 / 13611 / 13637
U.E.	S.6	S.6	S.6	S.6	S.3
Gris Anthracite	 3 086960 219161	 3 086960 212612	 3 086960 204013	 3 086960 204075	 3 086960 204419
Taupe	 3 086960 219178	 3 086960 212605	 3 086960 209483	 3 086960 206260	 3 086960 206277
Rouge rubis	 3 086960 236205	 3 086960 236182	 3 086960 236076	 3 086960 236069	 3 086960 235895
Bourgogne	 3 086960 273637	 3 086960 273644	 3 086960 273651	 3 086960 273668	 3 086960 273675
Vert laurier	 3 086960 263874	 3 086960 263881	 3 086960 263935	 3 086960 263942	 3 086960 263959
Blanc	 3 086960 230722	 3 086960 230746	 3 086960 204426	 3 086960 204389	 3 086960 204396

SOUCOUPES POUR POTS ROUNDS TOSCANE



VASES HAUTS ROUNDS TOSCANE ET XXL



RÉF.	013620	013624
Désignation	SOUCOUBE TOSCANE POUR POT Ø 60 CM	SOUCOUBE TOSCANE POUR POT Ø 80 CM
DIM (cm) POUR POTS	Ø 40,5 13614	Ø 54 13623
U.E.	S.3	S.2
Gris Anthracite	 3 086960 207441	 3 086960 219253
Taupe	 3 086960 209247	 3 086960 219260
Rouge rubis	 3 086960 235901	 3 086960 236229
Bourgogne	 3 086960 273682	 3 086960 273989
Vert laurier	 3 086960 263965	 3 086960 272890
Blanc	 3 086960 207434	 3 086960 230784

RÉF.	013629	013630	013637
Désignation	VASE MI-HAUT TOSCANE GARANTIE 5 ANS FRANCE MÉTROPOLITAINE	VASE HAUT TOSCANE GARANTIE 5 ANS FRANCE MÉTROPOLITAINE	VASE XXL TOSCANE GARANTIE 5 ANS FRANCE MÉTROPOLITAINE
DIM (cm) LITRAGE (L)	Ø 44 x 53 50	Ø 46 x 65 67	Ø 48 x 80 90
U.E.	S.3	S.3	S.2
Gris Anthracite	 3 086960 211462	 3 086960 208875	 3 086960 229610
Taupe	 3 086960 211479	 3 086960 208882	 3 086960 229627
Rouge rubis	 3 086960 235789	 3 086960 235840	 3 086960 236298
Bourgogne	 3 086960 273613	 3 086960 273620	
Vert laurier	 3 086960 263867	 3 086960 263331	 3 086960 272821
Blanc	 3 086960 230807	 3 086960 209599	 3 086960 230913

POTS CARRÉS TOSCANE A RESERVE D'EAU



POTS CARRÉS TOSCANE



RÉF.	013641	013642
Désignation	POT CARRÉ TOSCANE 18 CM AVEC SOUCOUBE CLIPSÉE RÉSERVE D'EAU	POT CARRÉ TOSCANE 25 CM AVEC SOUCOUBE CLIPSÉE RÉSERVE D'EAU
DIM (cm) LITRAGE (L)	17,4 x 17,4 x 17 3,4	24,8 x 24,8 x 24,6 10,2
U.E.	S.6	S.6
Gris Anthracite	 3 086960 235291	 3 086960 235376
Taupe	 3 086960 235277	 3 086960 235369
Rouge rubis	 3 086960 236311	 3 086960 236328
Bourgogne	 3 086960 273699	 3 086960 273705
Vert laurier	 3 086960 263973	 3 086960 263980
Blanc	 3 086960 235253	 3 086960 235338

RÉF.	013643	013627	013648
Désignation	POT CARRÉ TOSCANE 32 CM	POT CARRÉ TOSCANE 39 CM GARANTIE 5 ANS FRANCE MÉTROPOLITAINE	POT CARRÉ TOSCANE 50 CM GARANTIE 5 ANS FRANCE MÉTROPOLITAINE
DIM (cm) LITRAGE (L)	32 x 32 x 32 22	39 x 39 x 39 38	49,5 x 49,5 x 52,5 87
U.E.	S.6	S.3	S.3
Gris Anthracite	 3 086960 235451	 3 086960 211530	 3 086960 256630
Taupe	 3 086960 235444	 3 086960 211523	 3 086960 256623
Rouge rubis	 3 086960 236335	 3 086960 235802	 3 086960 256654
Bourgogne	 3 086960 273712	 3 086960 273729	 3 086960 256647
Vert laurier	 3 086960 263997	 3 086960 263348	 3 086960 273736
Blanc	 3 086960 235413	 3 086960 230951	 3 086960 256679

EAN COLLECTION D'INTÉRIEUR ET POTERIE DÉCO



POTS HAUTS CARRÉS TOSCANE ET XXL



RÉF.	013628	013635	013639
Désignation	POT MI-HAUT CARRÉ TOSCANE GARANTIE 5 ANS FRANCE MÉTROPOLITAINE	POT HAUT CARRÉ TOSCANE GARANTIE 5 ANS FRANCE MÉTROPOLITAINE	POT CARRÉ XXL TOSCANE GARANTIE 5 ANS FRANCE MÉTROPOLITAINE
DIM (cm) LITRAGE (L)	39 x 39 x 53 51	39 x 39 x 65 62	44 x 44 x 80 98
U.E.	S.3	S.3	S.2
Gris Anthracite	 3 086960 211554	 3 086960 211233	 3 086960 229689
Taupe	 3 086960 211547	 3 086960 211561	 3 086960 229702
Rouge rubis	 3 086960 236243	 3 086960 235833	 3 086960 236304
Bourgogne	 3 086960 273934	 3 086960 273941	
Vert jungle	 3 086960 264017	 3 086960 263355	 3 086960 272975
Blanc	 3 086960 230975	 3 086960 230890	 3 086960 230937

SOUCOUPES POUR POTS CARRÉS TOSCANE



RÉF.	013644	013626	013651
Désignation	SOUCOUCHE CARRÉE TOSCANE	SOUCOUCHE CARRÉE TOSCANE	SOUCOUCHE CARRÉE TOSCANE
DIM (cm) POUR POTS	26,7 x 26,7 x 3,8 13643	32,6 x 32,6 x 4,9 13627/13628 / 13635 / 13639	40 x 40 x 5,9 13648
U.E.	S.6	S.3	S.3
Gris Anthracite	 3 086960 235536	 3 086960 211257	 3 086960 256692
Taupe	 3 086960 235529	 3 086960 211516	 3 086960 256685
Rouge rubis	 3 086960 236359	 3 086960 236236	 3 086960 256715
Bourgogne	 3 086960 273958	 3 086960 273965	 3 086960 273972
Vert laurier	 3 086960 264024	 3 086960 264031	 3 086960 264048
Blanc	 3 086960 235499	 3 086960 230999	 3 086960 256678

MURET TOSCANE



RÉF.	013633
Désignation	MURET TOSCANE 80 CM, GARANTIE 5 ANS FRANCE MÉTROPOLITAINE AVEC RÉSERVE D'EAU ET GRILLE FILTRANTE - GOULOTTE D'ARRSAGE - TROP PLEIN - 2 BARRES DE RENFORT - 6 ROULETTES BI-DIRECTIONNELLES
DIM (CM) LITRAGE (L)	79 x 35 x 39 74
U.E.	S.3
Gris Anthracite	 3 086960 228361
Taupe	 3 086960 233679
Rouge rubis	 3 086960 236274
Vert laurier	 3 086960 273040

JARDINIÈRES TOSCANE AVEC PLATEAU - À RÉSERVE D'EAU



	RÉF.	013631	013632
Désignation		JARDINIÈRE TOSCANE AVEC PLATEAU CLIPSÉ DRAINAGE EN CROIX	JARDINIÈRE TOSCANE AVEC PLATEAU CLIPSÉ DRAINAGE EN CROIX
DIM (CM) LITRAGE (L)		50 x 18 x 16,7 10	60 x 18 x 16,7 13
U.E.		S.10	S.10
Gris Anthracite		 3 086960 209834	 3 086960 209858
Rouge rubis		 3 086960 236250	 3 086960 236267
Vert laurier		 3 086960 273026	 3 086960 273033



POTS OSAKA



	RÉF.	013577	013580	013581	013582	013583	013584
Désignation		POT OSAKA Ø20 CM	POT OSAKA Ø25 CM	POT OSAKA Ø30 CM	POT OSAKA Ø40 CM	POT OSAKA Ø50 CM	POT OSAKA Ø70 CM
DIM (cm) LITRAGE (L)		Ø 19,3 x 16 2,6	Ø 25,6 x 21,2 6,5	Ø 30,9 x 25,5 11,7	Ø 41 x 34,3 28,3	Ø 52 x 42,9 56,8	Ø 73,6 x 61,8 165
U.E.		S.6	S.6	S.6	S.6	S.3	S.3
Gris Anthracite		 3 086960 273996	 3 086960 266028	 3 086960 266059	 3 086960 266080	 3 086960 266110	 3 086960 266141
Vert laurier		 3 086960 274009	 3 086960 266035	 3 086960 266066	 3 086960 266097	 3 086960 266127	 3 086960 266158
Bourgogne		 3 086960 274016	 3 086960 266042	 3 086960 266073	 3 086960 266103	 3 086960 266134	 3 086960 266165



SOUCOUPES OSAKA



	RÉF.	R019215	R019221	R019230	R018145	R018146
Désignation		SOUCOUPE OSAKA POUR POT OSAKA Ø20 CM	SOUCOUPE OSAKA POUR POT OSAKA Ø25 ET 30 CM	SOUCOUPE OSAKA POUR POT OSAKA Ø40 CM	SOUCOUPE OSAKA POUR POT OSAKA Ø50 CM	SOUCOUPE OSAKA POUR POT OSAKA Ø70 CM
DIM (cm) POUR POTS		Ø 15 013577	Ø 21 013580 & 013581	Ø 30 013582	Ø 38 013583	Ø 55 013584
U.E.		S.10	S.10	S.10	S.3	S.3
Gris Anthracite		 3 086960 203771	 3 086960 203818	 3 086960 203856	 3 086960 252953	 3 086960 252991
Vert laurier		 3 086960 274023	 3 086960 266172	 3 086960 266196	 3 086960 266219	 3 086960 266233
Bourgogne		 3 086960 274030	 3 086960 266189	 3 086960 266202	 3 086960 266226	 3 086960 266240







EAN COLLECTION D'INTÉRIEUR ET POTERIE DÉCO

DISPLAY MINIS POTS OSAKA **N**

RÉF.	R015580	R015581
Désignation	DISPLAY MINI POT OSAKA 7,5 CM	DISPLAY MINI POT OSAKA 10,5 CM
DIM (CM) LITRAGE (L)	Ø 7,5 X 6,4 0,18	Ø 10,5 X 9 0,5
COMPOSITION	30 ● + 15 ● + 15 ●	21 ● + 10 ● + 11 ●
U.E.	D.60	D.42
	 3 086960 266257	 3 086960 266301





JARDINIÈRES CAVALIÈRES ET POTS CAVALIERS OSAKA **N**

RÉF.	013586	013585
Désignation	JARDINIÈRE CAVALIÈRE OSAKA	POT CAVALIER OSAKA
DIM (CM) LITRAGE (L)	56 x 30,1 x 20,6 19,5	Ø 30,6 x 20,6 8
U.E.	S.6	S.6
Gris Anthracite	 3 086960 266370	 3 086960 266349
Vert laurier	 3 086960 266387	 3 086960 266356
Bourgogne	 3 086960 266394	 3 086960 266363



JARDINIÈRES CAVALIÈRES - BOX **N**

RÉF.	R015586
DIM. L x l x H (CM)	56 x 30,1 x 20,6
LITRAGE (L)	19,5
COMPOSITION	24 ● + 12 ● + 6 ●
U.E.	B.42
	 3 086960 266400



JARDINIÈRE BASSE OSAKA **N**

RÉF.	013588
Désignation	JARDINIÈRE BASSE OSAKA AVEC BARRE MÉTALLIQUE DE RENFORT
DIM (CM) LITRAGE (L)	77,3 x 19,5 x 18,2 38
U.E.	S.3
Gris Anthracite	 3 086960 266417
Vert laurier	 3 086960 266424
Bourgogne	 3 086960 266431

SOUCOPE PLATEAU OSAKA **N**

RÉF.	013576
Désignation	SOUCOPE PLATEAU OSAKA POUR JARDINIÈRE BASSE OSAKA
DIM (CM) POUR JARDINIÈRE	69,1 x 22 x 2,9 13588
U.E.	S.3
Gris Anthracite	 3 086960 256777
Vert laurier	 3 086960 266448
Bourgogne	 3 086960 266455

JARDINIÈRE HAUTE OSAKA **N**

RÉF.	013587
Désignation	JARDINIÈRE HAUTE OSAKA AVEC BARRE MÉTALLIQUE DE RENFORT - ZONE DE RÉTENTION D'EAU - PIEDS AVEC TAMPONS AMOVIBLES
DIM (CM) LITRAGE (L)	77,1 x 37,6 x 68 48
U.E.	C.4
Gris Anthracite	 3 086960 266462
Vert laurier	 3 086960 266479

POTS CARRÉS CHORUS



RÉF.	013535	013536	013537	013538	013539
Désignation	POT CARRÉ NON PERCÉ CHORUS 20 CM	POT CARRÉ NON PERCÉ CHORUS 25 CM	POT CARRÉ NON PERCÉ CHORUS 30 CM	POT CARRÉ NON PERCÉ CHORUS 35CM	POT CARRÉ NON PERCÉ CHORUS 40 CM
DIM (cm) LITRAGE (L)	19,5 x 19,5 x 18,2 4,3	24,5 x 24,5 x 22,8 8,6	29,5 x 29,5 x 27,3 15,2	34,5 x 34,5 x 31,9 24,2	40 x 40 x 36,4 35,6
U.E.	S.10	S.10	S.10	S.10	S.10
Gris Anthracite	 3 086960 248048	 3 086960 248703	 3 086960 248758	 3 086960 248802	 3 086960 248857
Taupe	 3 086960 248031	 3 086960 248697	 3 086960 248741	 3 086960 248796	 3 086960 248840
Rouge rubis	 3 086960 248062	 3 086960 248727	 3 086960 248772	 3 086960 248826	 3 086960 248871
Gris béton	 3 086960 255923	 3 086960 255961	 3 086960 255992	 3 086960 256012	 3 086960 256036

SOUCOUPES POUR POTS CARRÉS CHORUS



RÉF.	013546	013547	013550	013551	013552
Désignation	SOUCOUBE CARRÉE CHORUS POUR POT 20 x 20 CM	SOUCOUBE CARRÉE CHORUS POUR POT 25 x 25 CM	SOUCOUBE CARRÉE CHORUS POUR POT 29,5 x 29,5 CM	SOUCOUBE CARRÉE CHORUS POUR POT 34,5 x 34,5 CM	SOUCOUBE CARRÉE CHORUS POUR POT 40 x 40 CM
DIM (cm) POUR POTS	17,5 x 17,5 x 1,7 13535	25 x 25 x 2 13536	26,8 x 26,8 x 2,3 13537	31,3 x 31,3 x 2,7 13538	36,2 x 36,2 x 3 13539
U.E.	S.10	S.10	S.10	S.10	S.10
Gris Anthracite	 3 086960 253592	 3 086960 253646	 3 086960 248901	 3 086960 248956	 3 086960 249007
Taupe	 3 086960 253608	 3 086960 253653	 3 086960 248895	 3 086960 248949	 3 086960 248994
Rouge rubis	 3 086960 253615	 3 086960 253660	 3 086960 248925	 3 086960 248963	 3 086960 249021
Gris béton	 3 086960 256050	 3 086960 256074	 3 086960 256098	 3 086960 256111	 3 086960 256135



JARDINIÈRES «CHORUS» AVEC PLATEAUX - À RÉSERVE D'EAU



RÉF.	013528	013529	013530	013531
Désignation	JARDINIÈRE CHORUS AVEC PLATEAU CLIPSÉ - DRAINAGE EN CROIX - VOLUME RÉSERVE D'EAU 0,1 L	JARDINIÈRE CHORUS AVEC PLATEAU CLIPSÉ - DRAINAGE EN CROIX - VOLUME RÉSERVE D'EAU 0,33 L	JARDINIÈRE CHORUS AVEC PLATEAU CLIPSÉ - DRAINAGE EN CROIX - VOLUME RÉSERVE D'EAU 0,42 L	JARDINIÈRE CHORUS AVEC PLATEAU CLIPSÉ - DRAINAGE EN CROIX - VOLUME RÉSERVE D'EAU 0,50 L
DIM (CM) LITRAGE (L)	30 x 12 x 11,4 2,6	39,8 x 18,8 x 16,1 7,5	48,8 x 18,8 x 16,1 9,4	58,8 x 18,8 x 16,1 11,6
U.E.	S.20	C.20	C.20	C.14
Gris Anthracite	 3 086960 233358	 3 086960 233600	 3 086960 230524	 3 086960 230562
Taupe	 3 086960 233365	 3 086960 233617	 3 086960 230531	 3 086960 230579
Rouge rubis	 3 086960 241476	 3 086960 241483	 3 086960 236946	 3 086960 241490
Gris béton	 3 086960 256364	 3 086960 256401	 3 086960 256449	 3 086960 256494

CHORUS - JARDINIÈRES + SUPPORT INVISIBLE



RÉF.	R011458	R011455
Désignation	JARDINIÈRE CHORUS 30 CM AVEC PLATEAU CLIPSÉ + SUPPORT INVISIBLE DRAINAGE EN CROIX - VOLUME 2,6 L VOLUME RÉSERVE D'EAU 0,1 L	JARDINIÈRE CHORUS 50 CM AVEC PLATEAU CLIPSÉ + SUPPORT INVISIBLE DRAINAGE EN CROIX - VOLUME 9,4 L VOLUME RÉSERVE D'EAU 0,42 L
DIM (CM) LITRAGE (L)	30 x 12 x 11,4 + support invisible 2,6	48,8 x 18,8 x 16,1 + support invisible 9,4
U.E.	C.10	C.10
Gris Anthracite	 3 086960 233402	 3 086960 230500
Taupe	 3 086960 233426	 3 086960 230517
Rouge rubis	 3 086960 241643	 3 086960 241650
Gris béton	 3 086960 256531	 3 086960 256555

CHORUS - BOX



RÉF.	R011455
Désignation	Jardinière CHORUS 50 cm & plateau clipsé + Support invisible
DIM (CM) LITRAGE (L)	48,8 x 18,8 x 16,1 9,45
COMPOSITION	23 ● + 22 ●
U.E.	B.45
	 3 086960 232832



POTS NON PERCES MARINA



RÉF.	R018118	R018120	R018125	R018130	R018135	R018140
Désignation	POT NON PERCÉ MARINA 18 CM	POT NON PERCÉ MARINA 20 CM	POT NON PERCÉ MARINA 25 CM	POT NON PERCÉ MARINA 30 CM	POT NON PERCÉ MARINA 35 CM	POT NON PERCÉ MARINA 40 CM
DIM (cm) LITRAGE (L)	Ø 18 x 15,3 2	Ø 20 x 17 3	Ø 25 x 21,5 6	Ø 30 x 25,5 10	Ø 35 x 29,5 16	Ø 40 x 33,7 23
U.E.	S.10	S.10	S.10	S.10	S.10	S.10
Gris Anthracite	 3 086960 203658	 3 086960 203672	 3 086960 203696	 3 086960 203719	 3 086960 203733	 3 086960 203757
Taupe	 3 086960 203641	 3 086960 203665	 3 086960 203689	 3 086960 203702	 3 086960 203726	 3 086960 203740
Rouge rubis	 3 086960 241230	 3 086960 241247	 3 086960 241254	 3 086960 241261	 3 086960 241278	 3 086960 241285
Gris béton	 3 086960 256609	 3 086960 254193	 3 086960 254216	 3 086960 254223	 3 086960 255893	 3 086960 255916

SOUCOUPES POUR POTS NON PERCES MARINA



RÉF.	R019215	R019217	R019221	R019226	R019230	R019234
Désignation	SOUCOUBE MARINA POUR POT Ø 18 CM	SOUCOUBE MARINA POUR POT Ø 20 CM	SOUCOUBE MARINA POUR POT Ø 25 CM	SOUCOUBE MARINA POUR POT Ø 30 CM	SOUCOUBE MARINA POUR POT Ø 35 CM	SOUCOUBE MARINA POUR POT Ø 40 CM
DIM (cm) POUR POTS	Ø 15 R018118	Ø 17 R018120	Ø 21 R018125	Ø 26 R018130	Ø 30 R018135	Ø 34 R018140
U.E.	S.10	S.10	S.10	S.10	S.10	S.10
Gris Anthracite	 3 086960 203771	 3 086960 203795	 3 086960 203818	 3 086960 203832	 3 086960 203856	 3 086960 203870
Taupe	 3 086960 203764	 3 086960 203788	 3 086960 203801	 3 086960 203825	 3 086960 203849	 3 086960 203863
Rouge rubis	 3 086960 241292	 3 086960 241308	 3 086960 241315	 3 086960 241322	 3 086960 241339	 3 086960 241346
Gris béton	 3 086960 255954	 3 086960 254209	 3 086960 252915	 3 086960 254230	 3 086960 252939	 3 086960 256234

BOX : POT MARINA Ø18 CM + SUPPORT METAL



RÉF.	R011457
Désignation	LOT 1 POT MARINA PERCÉ Ø 18 X 15,3 CM + SOUCOUBE Ø 15 CM + 1 SUPPORT GRIS MARTELÉ
DIM (CM)	Lot 1 pot MARINA percé Ø 18 x 15,3 cm + Soucoupe Ø 15 cm + 1 support gris martelé
COMPATIBLE	R018118
COMPOSITION	24 ● + 12 ●
U.E.	B.36
	 3 086960 624062

AÉRIA - SUSPENSION



RÉF.	R014127
Désignation	SUSPENSION AÉRIA PERCÉE AVEC SOUCOUBE ET TRINGLE DE SUSPENSION
DIM (CM) LITRAGE (L)	Ø 27 x 47 4,5
U.E.	S.25
Gris Anthracite	 3 086960 203634
Taupe	 3 086960 203627

EAN COLLECTION D'INTÉRIEUR ET POTERIE DÉCO

COUPES LOTUS N



RÉF.	022093	022094
Désignation	COUPE LOTUS AVEC SOUCOUBE CLIPSEE	COUPE LOTUS AVEC SOUCOUBE CLIPSEE
DIM (CM)	Ø 25 x 12,6	Ø30 x 15
LITRAGE (L)	3	5,3
U.E.	S.10	S.10
Gris Anthracite	8	
	6	
Taupe	6	

SUPPORTS POT BALCON N



RÉF.	019184	019185
Désignation	SUPPORT POUR POT BALCON	SUPPORT POUR POT BALCON
DIM (CM)	Ø 18	Ø23
U.E.	C.12	C.12
Gris Anthracite	8	

SUPPORTS MÉTALLIQUES N



RÉF.	019180	019181	019182
Désignation	SUPPORT STANDARD AVEC SECURITE	SUPPORT STANDARD LARGE AVEC SECURITE	SUPPORT STANDARD AVEC SECURITE
DIM (CM)	37 x 28 x 20	39 x 30 x 23	48 x 27 x 20
U.E.	C.12	C.12	C.12
Gris Anthracite	8		

SUPPORT MÉTALLIQUE N



RÉF.	019183
Désignation	SUPPORT RÉGLABLE MARTELÉ SECURITE FER PLAT
DIM (CM)	37 x 30 x 21
U.E.	C.6
Gris Anthracite	8

BACS À ARBUSTES PALMEA À RÉSERVE D'EAU



JARDINIÈRES À ARBUSTES PALMEA À RÉSERVE D'EAU



RÉF.	013900	013901	013909	013904
Désignation	BAC À ARBUSTES ROND PALMEA AVEC ROULETTES	BAC À ARBUSTES CARRÉ PALMEA AVEC ROULETTES	BAC «VASE» CARRÉ À ARBUSTES PALMEA	JARDINIÈRE PALMEA
DIM (CM) LITRAGE (L)	Ø 70 x 55 sur roulettes 98	70x70x55 110	47 x 47 x 65 65	120 x 47 x 42 124
U.E.	V.1	V.1	V.1	V.1
Taupe	6			
	30			
Gris	30			

BACS CHARME À RÉSERVE D'EAU





JARDINIÈRES CHARME À RÉSERVE D'EAU



RÉF.	013810	013815	013816	013817
Désignation	BAC CARRÉ CHARME	BAC CARRÉ CHARME	JARDINIÈRE RECTANGULAIRE CHARME	JARDINIÈRE RECTANGULAIRE CHARME
DIM (CM) LITRAGE (L)	40 x 40 x 40 31	50 x 50 x 50 67	100 x 40 x 40 90	119 x 50 x 50 155
U.E.	V.1	V.1	V.1	V.1
Gris céruisé	31			



SOUCOUPES À ROULEAUX





RÉF.	010942	010943
Désignation	SOUCOUPE À ROULEAUX Ø35CM 4 ROULEAUX	SOUCOUPE À ROULEAUX Ø45CM 5 ROULEAUX
DIM (CM)	ø34,5 x 5,7	ø45 x 5,7
U.E.	C.12	C.12
Gris anthracite		

SUPPORTS À ROULETTES DÉCOR PIERRE



RÉF.	10940	10941
Désignation	SUPPORT À ROULETTES	SUPPORT À ROULETTES
POUR POTS	Ø 30 - 5 Roulettes	Ø 40 - 6 Roulettes
U.E.	S.4 / C.24	S.4 / C.24
Ardoise		

PRÉSENTOIR SUPPORT À ROULETTES

RÉF.	90940	90941
Désignation	PRÉSENTOIR POUR SUPPORT À ROULETTES	PRÉSENTOIR POUR SUPPORT À ROULETTES
POUR POTS	Ø 30	Ø 40
U.E.	1	1
Métal		





SUPPORTS À ROULETTES MÉTALLIQUES





RÉF.	10937
Désignation	SUPPORT EXTENSIBLE À ROULETTES 4 ROUES MULTI-DIRECTIONNELLES
POUR POTS	Pour pots carrés ou ronds (de 28,5 à 40,5 cm)
U.E.	C.12
Gris Métal	

SUPPORTS À ROULETTES BOIS



RÉF.	10949	10955
Désignation	SUPPORT À ROULETTES Ø30CM EN BOIS DE HÊTRE 4 ROULETTES	SUPPORT À ROULETTES Ø38CM EN BOIS DE HÊTRE 4 ROULETTES
DIM (CM)	ø30cm	ø38cm
U.E.	C.6	C.6
Bois hêtre		

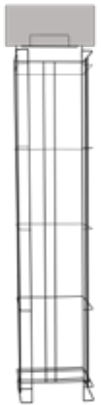

PRÉSENTOIR SUPPORTS A ROULETTES BOIS

RÉF.	R011949	R011955
Désignation	LOT DE 18 SUPPORTS À ROULETTES Ø30CM EN BOIS DE HÊTRE + 1 PRÉSENTOIR	LOT DE 18 SUPPORTS À ROULETTES Ø38CM EN BOIS DE HÊTRE + 1 PRÉSENTOIR
DIM (CM)	33 x 33 x 160	43,5 x 43,5 x 160
COMPOSITION	1 PRÉSENTOIR + 18 SUPPORTS	1 PRÉSENTOIR + 18 SUPPORTS
U.E.	1 PRÉSENTOIR + 3 x C.6	1 PRÉSENTOIR + 3 x C.6
Noir métal		





SUPPORTS À ROULETTES BOIS



RÉF.	10950	10956
Désignation	SUPPORT À ROULETTES 29 X 29CM EN BOIS DE HÊTRE 4 ROULETTES	SUPPORT À ROULETTES 40 X 40CM EN BOIS DE HÊTRE 4 ROULETTES
DIM (CM)	29 x 29	40 x 40
U.E.	C.6	C.6
Bois hêtre		

PRÉSENTOIR SUPPORTS A ROULETTES BOIS

RÉF.	R011950	R011956
Désignation	LOT DE 18 SUPPORTS À ROULETTES 29 X 29CM EN BOIS DE HÊTRE + 1 PRÉSENTOIR	LOT DE 18 SUPPORTS À ROULETTES 40 X 40CM EN BOIS DE HÊTRE + 1 PRÉSENTOIR
DIM (CM)	33 x 33 x 160	43,5 x 43,5 x 160
COMPOSITION	1 PRÉSENTOIR + 18 SUPPORTS	1 PRÉSENTOIR + 18 SUPPORTS
U.E.	1 PRÉSENTOIR + 3 x C.6	1 PRÉSENTOIR + 3 x C.6
Noir métal		





EAN AROMATIQUES ET POTAGER

ESPACE POTAGER VEG&TABLE™ MAX



SERRE pour
ESPACE POTAGER
VEG&TABLE™ MAX



RÉF.	013925
Désignation	ESPACE POTAGER VEG&TABLE™ MAX AVEC ZONE DE RÉTENTION D'EAU- PIEDS AVEC TAMPONS AMOVIBLES POUR ÉVACUATION TROP PLEIN
DIM (CM) Litrage (L)	75,6 x 55,6 x 68 85
U.E.	C.4
Gris Anthracite	8  3 086960 250041
Taupe	6  3 086960 250034

RÉF.	013926
Désignation	SERRE DE CULTURE POUR ESPACE POTAGER VEG&TABLE™ MAX GRANDE OUVERTURE LATÉRALE, POUR ARROSER, CUEILLIR SANS ENLEVER LA SERRE
DIM (CM) COMPATIBLE	74,8 x 54,8 x 26,5 13925
U.E.	S.4
Naturel	2  3 086960 250058

LOT VEG&TABLE MAX + SERRE DE CULTURE





RÉF.	R014925
Désignation	LOT : ESPACE POTAGER VEG&TABLE™ MAX + SERRE DE CULTURE VEG&TABLE™ MAX ESPACE POTAGER
U.E.	B.14
Gris anthracite+ Serre Naturel	14 x 8 14 x 2  3 086960 251628

ESPACE POTAGER VEG&TABLE™ CITY



SERRE DE CULTURE POUR ES-
PACE POTAGER VEG&TABLE™
CITY





RÉF.	013923
Désignation	ESPACE POTAGER VEG&TABLE™ CITY AVEC ZONE DE RÉTENTION D'EAU -PIEDS AVEC TAMPONS AMOVIBLES POUR ÉVACUATION TROP PLEIN
DIM (CM) Litrage (L)	76 x 38,5 x 68 57
U.E.	C.4
Gris Anthracite	8  3 086960 241025
Taupe	6  3 086960 241018

RÉF.	013924
Désignation	SERRE DE CULTURE POUR ESPACE POTAGER VEG&TABLE™ CITY DOUBLE AÉRATION AVEC DÉBIT D'AIR VARIABLE
DIM (CM) COMPATIBLE	75 x 37,5 x 21,5 13923
U.E.	S.4
Naturel aérateur Gris anthracite	2  3 086960 241001

LOT VEG&TABLE CITY + SERRE DE CULTURE



RÉF.	R014198
Désignation	BOX: LOT ESPACE POTAGER VEG&TABLE™ CITY + SERRE DE CULTURE
U.E.	B.13
Gris anthracite Serre naturel	13 x 8 13 x 2  3 086960 244415
Taupe Serre naturel	13 x 6 13 x 2  3 086960 250072





ESPACE POTAGER VEG&TABLE™ GARDEN



RÉF.	013919
Désignation	ESPACE POTAGE VEG&TABLE™ GARDEN
DIM (CM) LITRAGE (L)	79 x 59 x 24,5 67
U.E.	S.2
Gris Anthracite	 3 086960 253752

ESPACE POTAGER VEG&TABLE™ AROMATIQUE



RÉF.	013927
Désignation	ESPACE POTAGER VEG&TABLE™ AROMATIQUE AVEC ZONE DE RÉTENTION D'EAU-PIEDS AVEC TAMPONS AMOVIBLES POUR ÉVACUATION TROP PLEIN
DIM (CM) Litrage (L)	38,5 x 38,5 x 68 23
U.E.	C.4
Gris Anthracite	 3 086960 261818
Taupe	 3 086960 261825

SERRE pour ESPACE POTAGER VEG&TABLE™ AROMATIQUE



RÉF.	013928
Désignation	SERRE DE CULTURE POUR ESPACE AROMATIQUE VEG&TABLE™ URBAN
DIM (CM) COMPATIBLE	37,6 x 37 x 21,6 13927
U.E.	S.4
Naturel	 3 086960 261832

MINIS SERRES DE CULTURE



RÉF.	013932	013933
Désignation	MINI SERRE DE CULTURE -TAILLE M	MINI SERRE DE CULTURE -TAILLE L
DIM (CM) LITRAGE (L)	38 x 25,5 x 19 5,7	56 x 38 x 24 15,7
U.E.	C.4	C.4
Gris Anthracite	 3 086960 249922	 3 086960 249946
Taupe	 3 086960 249915	 3 086960 249939

TUTEUR VEG&TABLE™



RÉF.	013947
Désignation	TUTEUR VEG&TABLE™
DIM (CM) PRODUIT MONTÉ	ø25 x 66,3
U.E.	C.12
Vert canada	 3 086960 257279

PIÈGE À GUÊPES **N**



RÉF.	022185
Désignation	PIÈGE À GUÊPES
DIM (CM)	18,5 x 18 x 15
U.E.	C.10
Naturel	 3 167890 020000

TAPETTE À MOUCHES **N**



RÉF.	022185
Désignation	TAPETTE À MOUCHES
DIM (CM)	47 x 10 x 1
U.E.	C.50
Assortiment	 3 167890 020055

EAN AMÉNAGEMENT EXTÉRIEUR

MALLE DE JARDIN BAYA 420 L



RÉF.	010290	
Désignation	MALLE DE JARDIN BAYA 420 L - DÉCOR BOIS ANTI ÉTOUFFEMENT - ANTI U.V. - CARTON DE 1 PIÈCE EN KIT	
DIM (CM) LITRAGE (L)	117,3 x 54,8 x 65,3 420	
U.E.	P.5 / P.13	
Taupe		
Gris anthracite		

COFFRE DE JARDIN BAYA



RÉF.	010292	010291
Désignation	COFFRE DE JARDIN BAYA 160 L DÉCOR BOIS - COUVERCLE CLIPSABLE - ÉTANCHE	COFFRE DE JARDIN BAYA 250 L DÉCOR BOIS - COUVERCLE CLIPSABLE - ÉTANCHE
DIM (CM) LITRAGE (L)	72,5 x 54,5 x 51,5 160	97,5 x 54,7 x 60 250
U.E.	S.2 / P.16	P.8 / P.14
Gris Foncé		

MALLE DE JARDIN SERENA



RÉF.	010191	010194
Désignation	MALLE DE JARDIN SERENA 310 L CADENASSABLE AVEC ROULETTES - ANTI ÉTOUFFEMENT - ANTI UV - CARTON DE 1 PIÈCE EN KIT	MALLE DE JARDIN MAXI SERENA 500 L CADENASSABLE AVEC ROULETTES - ANTI ÉTOUFFEMENT - ANTI U.V. - CARTON DE 1 PIÈCE EN KIT
DIM (CM) LITRAGE (L)	121 x 55 x 66 avec roulettes 310	121 x 76 x 67 avec roulettes 500
U.E.	P.8	P.6
Taupe		
Gris Anthracite		

DALLES CLIPSABLES



RÉF.	010902	019939
Désignation	DALLE EN PLASTIQUE IMITATION BOIS - RÉSISTANCE UV 3 ANS - RÉSISTANT AU CHOLRE - FIXATION PAR CLIPSAGE - ASSEMBLAGE ET POSE FACILE SANS ENTRETIEN	DALLE EN PLASTIQUE IMITATION BOIS - RÉSISTANCE UV 3 ANS - RÉSISTANT AU CHOLRE - FIXATION PAR CLIPSAGE - ASSEMBLAGE ET POSE FACILE SANS ENTRETIEN
DIM (CM)	39,9 x 39,9 x 2,5	49,5 x 49,5 x 2,5
U.E.	C.36 / P.198	F.8
Taupe		
Noir		

PIEDS DE PARASOL À REMPLIR



RÉF.	019636	
Désignation	PIED DE PARASOL 20L ROND À REMPLIR POUR TIGE Ø 3,2 À 5 CM 20 KG REMPLI D'EAU / 32 KG REMPLI DE SABLE*	
DIM (CM) Ø MAT (CM)	ø49,5 x 14,5 3,2 à 5	
U.E.	S.4 / P.48	
Gris foncé / béton		
Gris foncé / vert laurier		

PIEDS DE PARASOL À REMPLIR

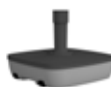

RÉF.	019637	
Désignation	PIED DE PARASOL 25L CARRÉ À REMPLIR SUR ROULEAUX POUR TIGE Ø 3,2 À 5 CM 25 KG REMPLI D'EAU / 40 KG REMPLI DE SABLE*	
DIM (CM) Ø MAT (CM)	49,5 x 49,5 x 14,5 3,2 à 5	
U.E.	S.4 / P.48	
Gris foncé / béton		

PIEDS DE PARASOL BÉTON ROND



RÉF.	019646	019651	019644
Désignation	PIED DE PARASOL BÉTON ROND 14 KG POUR TIGE Ø 1,8 À 3,3 CM	PIED DE PARASOL BÉTON ROND 27 KG ENVIRON AVEC ROULETTES DÉCOR IMITATION BOIS POUR MÂT Ø 3,2 À 5 CM	PIED DE PARASOL BÉTON ROND 27 KG ENVIRON DÉCOR «TRESSÉ» POUR MÂT Ø 3,2 À 5 CM
DIM (CM) POIDS (KG) Ø MAT (CM)	Ø 38 x 25 14 1,8 à 3,3	Ø 48,5 x 31 27 3,2 à 5	Ø 48,5 x 31 27 3,2 à 5
U.E.	P.36	P.16	P.16
Blanc	2	/	
Gris Foncé	32		



PIEDS DE PARASOL BÉTON CARRÉ



RÉF.	019649	019702	019650
Désignation	PIED DE PARASOL DE BALCON BÉTON 20 KG ENVIRON DÉCOR GOUGE POUR MÂT Ø 3,2 À 5 CM	PIED DE PARASOL BÉTON CARRÉ 25 KG ENVIRON POUR MÂT Ø 3,2 À 5 CM	PIED DE PARASOL BÉTON 30 KG ENVIRON AVEC ROULETTES DONT 2 FREINS DÉCOR GOUGE POUR MÂT Ø 3,2 À 5 CM
DIM (CM) POIDS (KG) Ø MAT (CM)	39,4 x 29,3 x 34 20 3,2 à 5	43,5 x 43,5 x 34 25 3,2 à 5	48,5 x 48,5 x 31 30 3,2 à 5
U.E.	P.16	P.24	P.16
Blanc	/		
Gris Foncé			32

PIEDS DE PARASOL PLASTIQUE ROND



RÉF.	010703	019703
Désignation	PIED DE PARASOL ROND 13 L À REMPLIR POUR TIGE Ø 1,8 À 3,2 CM 13 KG REMPLI D'EAU / 18 KG REMPLI DE SABLE*	PIED DE PARASOL ROND 13 L À REMPLIR POUR TIGE Ø 1,8 À 3,2 CM 13 KG REMPLI D'EAU / 18 KG REMPLI DE SABLE*
DIM (CM) Ø MAT (CM)	Ø 43 x 28 1,8 à 3,2	Ø 43 x 28 1,8 à 3,2
U.E.	S.6 / P.60	C.16
Blanc	2	
Gris Foncé	32	

PIEDS DE PARASOL PLASTIQUE CARRÉ



RÉF.	010704
Désignation	PIED DE PARASOL CARRÉ 14 L À REMPLIR POUR TIGE Ø 1,8 À 3,2 CM 14 KG REMPLI D'EAU / 19 KG REMPLI DE SABLE*
DIM (CM) Ø MAT (CM)	42 x 42 x 28 1,8 à 3,2
U.E.	S.10 / P.60
Blanc	2

PIEDS DE PARASOL PLASTIQUE CARRÉ



RÉF.	010607
Désignation	PIED DE PARASOL CARRÉ 40 L À REMPLIR, SUR ROULETTES AVEC POIGNÉE POUR TIGE Ø 4 À 5,6 CM 40 KG REMPLI D'EAU / 52 KG REMPLI DE SABLE*
DIM (CM) Ø MAT (CM)	56,5 x 56,5 x 31,5 4 à 5,6
U.E.	S.4 / P.20
Blanc	2
Gris Foncé	32

EAN AMÉNAGEMENT EXTÉRIEUR

LEST BÉTON 22 KGS



RÉF.	019633
Désignation	LEST BÉTON 22 KG POUR MÂT DÉPORTÉ - DÉCOR GOUGE
DIM (CM) POIDS (KG)	49,5 x 49,5 x 5 22
U.E.	P.28
Gris Foncé	  3 086960 248536

LEST À REMPLIR POUR MAT DEPORTE



RÉF.	019680
Désignation	LEST À REMPLIR POUR MÂT DÉPORTÉ 14 KG REMPLI D'EAU / 22 KG REMPLI DE SABLE*
DIM (CM)	49 x 49 x 8,7
U.E.	S.4 / P.60
Gris Foncé	  3 086960 221171



LEST BÉTON DECORS PIERRE



RÉF.	019632
Désignation	LEST BÉTON 18 KG POUR MÂT DÉPORTÉ DÉCOR PIERRE
DIM (CM) POIDS (KG)	49 x 49 x 5,2 18
U.E.	P.20 / P.40
Ardoise	  3 086960 216344



LEST BÉTON TRIANGULAIRE 12 KGS



RÉF.	019634
Désignation	LEST BÉTON MODULABLE 12 KG POUR MÂT DÉPORTÉ PEUT S'IMBRIQUER 2 PAR 2 POUR NE FORMER QU'UNE SEULE DALLE DE 24 KG
DIM (CM) POIDS (KG)	48 x 48 x 5,8 12
U.E.	P.32
Gris Foncé	  3 086960 248529



PIED DE TONNELLE BÉTON



RÉF.	010706
Désignation	PIED DE TONNELLE EN BÉTON 14 KG POUR TIGE Ø 2 À 3,5 CM
DIM (CM) Ø MAT (CM)	20,5 x 19 x 34 2 à 3,5
U.E.	P.36
Blanc	  3 086960 064792

PIED DE TONNELLE À REMPLIR



RÉF.	010705
Désignation	PIED DE TONNELLE À REMPLIR POUR TIGE Ø 2 À 3,2 CM 8 KG REMPLI D'EAU / 11 KG REMPLI DE SABLE*
DIM (CM) POIDS (KG) Ø MAT (CM)	Ø 24 x 25,5 2 x 4 L 2 à 3,2
U.E.	S.4
Blanc	  3 086960 051822



EAN GESTION DE L'EAU

ARROSOIRS



	RÉF.	013271	010756
	Désignation	ARROSOIR LONG BEC 2 L	ARROSOIR 3 L LONG BEC «ESCARGOT»
	DIM (CM) LITRAGE (L)	48 x 12 x 23 2	56 x 12 x 23 3
	U.E.	S.8	S.12
Vert Matcha			

ARROSOIR ET PULVÉRISATEUR FUCHSIA

N



	RÉF.	022180	022181
	Désignation	ARROSOIR FUCHSIA 1,5 L	VAPORISATEUR FUCHSIA 1,5 L
	DIM (CM) LITRAGE (L)	32 x 11,5 x 17 1,5	11 x 7,5 x 25,5 0,7
	U.E.	C.4	C.4
Bleu			
Vert citron			
Framboise			
Naturel			
Jaune			
Gris			
Vert sapin			

ARROSOIR OVALES «PARISIENS» AVEC POMME



	RÉF.	019600	019583
	Désignation	ARROSOIR OVALE «PARISIEN» AVEC POMME 3 L	ARROSOIR OVALE «PARISIEN» AVEC POMME 6 L
	DIM (CM) LITRAGE (L)	42 x 12 x 27 3	52 x 14,5 x 34 6
	U.E.	S.10	S.10
Vert Métal			

ARROSOIR ET PULVÉRISATEUR EMMA

N



	RÉF.	022178	022177
	Désignation	ARROSOIR EMMA 2,5 L	VAPORISATEUR EMMA 1 L
	DIM (CM) LITRAGE (L)	52 x 14 x 26,5 2,5	14 x 14 x 26 1
	U.E.	S.8	S.8
Taupe			
Bleu jean			
Curcuma			

PULVÉRISATEUR



	RÉF.	010619
	Désignation	PULVÉRISATEUR 1L AVEC GÂCHETTE
	DIM (CM) LITRAGE (L)	12,5 x 9,2 x 26 1
	U.E.	C.12
Gris anthracite		

ARROSOIRS OVALES PARISIENS



	RÉF.	010600	010583
	Désignation	ARROSOIR OVALE 3 L «PARISIEN» AVEC POMME NOIRE	ARROSOIR OVALE 6 L «PARISIEN» AVEC POMME NOIRE
	DIM (CM) LITRAGE (L)	42 x 12 x 27 3	52 x 14,5 x 34,5 6
	U.E.	S.10	S.10
Vert Matcha			

EAN GESTION DE L'EAU

ARROSOIR «PROMO» AVEC POMME



RÉF.	019552	019658
Désignation	ARROSOIR PARISIEN 11 L «PROMO»	ARROSOIR «PROMO» 11 L
DIM (CM) LITRAGE (L)	60 x 18,5 x 40 11	57 x 18 x 38,5 11
U.E.	S.6 / B.52	S.6
Vert Métal		

ARROSOIRS OVALES LUXE



RÉF.	010737	010848
Désignation	ARROSOIR OVALE 12 L «LUXE» AVEC PIED RENFORCÉ - POMME NOIRE	ARROSOIR OVALE 15 L «LUXE» AVEC PIED RENFORCÉ - POMME NOIRE AVEC GRILLE MÉTAL
DIM (CM) LITRAGE (L)	65 x 22 x 41 12	73 x 19,5 x 45 15
U.E.	S.5	S.4
Vert Métal		

ARROSOIR EXTRA FORT



RÉF.	013201
Désignation	ARROSOIR 13 L «EXTRA FORT» AVEC POMME NOIRE AVEC GRILLE MÉTAL
DIM (cm) LITRAGE (L)	57 x 19 x 44 13
U.E.	S.5
Gris anthracite	

ARROSOIR ROND «LYONNAIS» AVEC POMME



RÉF.	019630	019541
Désignation	ARROSOIR ROND 6 L «LYONNAIS»	ARROSOIR ROND 11 L «LYONNAIS»
DIM (cm) LITRAGE (L)	45 x 16,5 x 33 6	55 x 19,5 x 44 11
U.E.	S.10	S.5
Vert Métal		

POMMES D'ARROSOIRS



RÉF.	013002	013003	013004	013005
Désignation	POMME D'ARROSOIR 3 L	POMME D'ARROSOIR 6 L	POMME D'ARROSOIRS 11 L ET 14 L	POMME D'ARROSOIRS AVEC GRILLE MÉTAL 12 L, 13 L, 15 L
DIM (CM) LITRAGE (L)	Ø 8,5 x 10 3	Ø 10,5 x 12,5 6	Ø 12,5 x 14,5 11 / 14	Ø 12,5 x 14,5 12 / 13 / 15
U.E.	20	20	20	20
Noir				

RAMPE D'ARROSAGE



RÉF.	010614
Désignation	RAMPE D'ARROSAGE LARGEUR D'ARROSAGE VARIABLE 5 À 50 CM
DIM (cm)	5 à 50
U.E.	C.12
Vert canada	

RÉCUP'O 300L



RÉF.	010985
Désignation	RÉCUPÉRATEUR D'EAU 300 L "RECUP'O" ROBINET AVEC EMBOUT POUR RACCORDEMENT AUTOMATIQUE DU TUYAU D'ARROSAGE, BOUCHON DE VIDANGE VISSÉ, TRAPPE SUR LE DESSUS DE LA CUVE, PRÉ PERÇAGES POUR RACCORDEMENT CHÉNEAUX ET / OU JUMELAGE DE CUVES, ET POUR ACCROCHAGE MURAL
DIM (cm) LITRAGE (L)	60 x 40 x 137 300
U.E.	P.4
Gris anthracite	

RÉCUP'DÉCO



RÉF.	010963
Désignation	RÉCUPÉRATEUR D'EAU 150L RÉCUP'DÉCO ROBINET (LIVRÉ NON MONTÉ) BOUCHON DE VIDANGE VISSÉ (LIVRÉ MONTÉ) PRÉ PERÇAGE POUR RACCORDEMENT CHÉNEAUX ET / OU JUMELAGE DE CUVES ET POUR ACCROCHAGE MURAL
DIM (cm) LITRAGE (L)	59,4 x 50,3 x 101,3 150
U.E.	P.16
Noir Gris anthracite	

RÉCUPÉRATEUR D'EAU



RÉF.	010964
Désignation	RÉCUPÉRATEUR D'EAU 310 L «RECUP'ECO» + KIT COLLECTEUR ROBINET (LIVRÉ NON MONTÉ), PRÉ-PERÇAGE POUR BOUCHON DE VIDANGE (NON FOURNI), TRAPPE SUR LE DESSUS DE LA CUVE, PRÉ PERÇAGES POUR RACCORDEMENT CHÉNEAUX ET / OU JUMELAGE DE CUVES, ET POUR ACCROCHAGE MURAL
DIM (CM) LITRAGE (L)	60 x 40 x 138 310
U.E.	P.4
Gris anthracite	
Beige	

RÉCUPÉRATEUR D'EAU



RÉF.	010982	010983
Désignation	RÉCUPÉRATEUR D'EAU 250 L "RECUP'O" SOUPLE ET PLIABLE	RÉCUPÉRATEUR D'EAU 500 L "RECUP'O" SOUPLE ET PLIABLE
DIM (CM) LITRAGE (L)	ø60 x 88 250	ø80 x 98 500
U.E.	C.6	C.4
Vert canada 	 3 086960 265953	 3 086960 265960



RÉCUPÉRATEUR D'EAU



RÉF.	010919	010908
Désignation	RÉCUPÉRATEUR D'EAU 350 L "RECUP'O" + KIT COLLECTEUR ROBINET AVEC EMBOUT POUR RACCORDEMENT AUTOMATIQUE DU TUYAU D'ARROSAGE (LIVRÉ MONTÉ), BOUCHON DE VIDANGE VISSÉ (LIVRÉ MONTÉ), TRAPPE SUR LE DESSUS DE LA CUVE, PRÉ PERÇAGES POUR RACCORDEMENT CHÈNEAUX ET / OU JUMELAGE DE CUVES, ET POUR ACCROCHAGE MURAL	RÉCUPÉRATEUR D'EAU 550 L "RECUP'O" + KIT COLLECTEUR ROBINET AVEC EMBOUT POUR RACCORDEMENT AUTOMATIQUE DU TUYAU D'ARROSAGE (LIVRÉ MONTÉ), BOUCHON DE VIDANGE VISSÉ (LIVRÉ MONTÉ), TRAPPE SUR LE DESSUS DE LA CUVE, PRÉ PERÇAGES POUR RACCORDEMENT CHÈNEAUX ET / OU JUMELAGE DE CUVES, ET POUR ACCROCHAGE MURAL
DIM (CM) LITRAGE (L)	65 x 50 x 144 350	79 x 56 x 164 550
U.E.	P.4	P.2
Gris anthracite 	 3 086960 252380	 3 086960 264116





RÉCUPÉRATEUR D'EAU



RÉF.	010914	010910
Désignation	RÉCUPÉRATEUR D'EAU 500 L ROTOMOULÉ «RECUP'O» + KIT COLLECTEUR GRADUÉ AVEC BILLE INDICATRICE DE NIVEAU D'EAU, ROBINET MONTÉ SUR INSERT MÉTALLIQUE AVEC EMBOUT POUR RACCORDEMENT AUTOMATIQUE DU TUYAU D'ARROSAGE (LIVRÉ MONTÉ), BOUCHON DE VIDANGE, TRAPPE Ø 17 CM SUR LE DESSUS DE LA CUVE, PRÉ PERÇAGES POUR RACCORDEMENT CHÈNEAUX ET / OU JUMELAGE DE CUVES, ET POUR ACCROCHAGE MURAL, STRUCTURE RENFORCÉE AU DOS	RÉCUPÉRATEUR D'EAU 1 000 L ROTOMOULÉ «RECUP'O» + KIT COLLECTEUR GRADUÉ AVEC BILLE INDICATRICE DE NIVEAU D'EAU, ROBINET MONTÉ SUR INSERT MÉTALLIQUE AVEC EMBOUT POUR RACCORDEMENT AUTOMATIQUE DU TUYAU D'ARROSAGE (LIVRÉ MONTÉ), BOUCHON DE VIDANGE, TRAPPE Ø 17 CM SUR LE DESSUS DE LA CUVE, PRÉ PERÇAGES POUR RACCORDEMENT CHÈNEAUX ET / OU JUMELAGE DE CUVES, ET POUR ACCROCHAGE MURAL, STRUCTURE RENFORCÉE AU DOS
DIM (CM) LITRAGE (L)	80 x 64 x 152 500	107 x 80 x 181 1000
U.E.	P.2	P.1
Beige 	 3 086960 167806	 3 086960 186838

KIT COLLECTEUR PREMIUM CAPT'EAU



RÉF.	010946	010947
Désignation	CAPT'EAU: POUR TOUT RÉCUPÉRATEUR D'EAU : 1 ÉCOPE AVEC ROBINET + 1 COLLIER POUR DIAM. 8 ET 10 CM + 1 COUDE DE SORTIE 90° + 1 SCIE CLOCHE + 2 VIS AUTOFORÉUSES + 1 JOINT MOUSSE AUTO-COLLANT + RACCORDEMENT À LA RÉSERVE AVEC TUYAU PVC DE 20 CM ADAPTABLE À TOUTES LES GOUITTIÈRES Ø 8 À 10 CM	CAPT'EAU: POUR TOUT RÉCUPÉRATEUR D'EAU : 1 ÉCOPE AVEC ROBINET + 1 COLLIER POUR DIAM. 8 ET 10 CM + 1 COUDE DE SORTIE 90° + 1 SCIE CLOCHE + 2 VIS AUTOFORÉUSES + 1 JOINT MOUSSE AUTO-COLLANT + RACCORDEMENT À LA RÉSERVE AVEC TUYAU PVC DE 20 CM ADAPTABLE POUR GOUITTIÈRES CÔTÉ 8 À 10 CM
DIM (CM)	rond - pour gouttière Ø 8 à 10 cm 20,2 x 10,5 x 28,5	carré - pour gouttière 8 à 10 cm 20,2 x 10,5 x 28,5
U.E.	C.6	C.6
Gris 	 3 086960 213589	
Beige 	 3 086960 213602	 3 086960 213619

ROBINET 3/4 GAZ

RÉF.	401917
Désignation	ROBINET POUR RÉCUPÉRATEUR D'EAU 3/4 GAZ + JOINT NOIR
U.E.	S.10
	 3 086960 156503

KIT DE JUMELAGE

RÉF.	010915
Désignation	KIT DE JUMELAGE UNIVERSEL POUR RÉCUPÉRATEUR D'EAU : 2 EMBOUTS 3/4 GAZ + 2 JOINTS + 2 ÉCROUS 3/4 GAZ + TUYAU DE 32 CM
DIM (CM)	38 x 4,5
U.E.	S.10
	 3 086960 166946

KIT COLLECTEUR

RÉF.	010916
Désignation	KIT COLLECTEUR: POUR TOUT RÉCUPÉRATEUR D'EAU : 1 COLLECTEUR AVEC GRILLE FILTRANTE ET SYSTÈME DE TROP PLEIN + 1 EMBOUT DE RACCORDEMENT 3/4 GAZ + 1 TUYAU PVC Ø 2 CM (INT.) - POSITION «ÉTE» (OUVERT) ET «HIVER» (FERMÉ) ADAPTABLE À TOUTES LES GOUITTIÈRES Ø 6,5 À 10 CM
U.E.	S.10
Gris 	 3 086960 156589

EAN OUTILLAGE ET UTILITAIRE



BROUETTE DE JARDIN



RÉF.	010334
Désignation	BROUETTE DE JARDIN 140 L LIVRÉE MONTÉE - TABLIER PERCÉ POUR LE RANGEMENT D'OUTILS À MAINS - PETIT BAC INTÉGRÉ POUR LES ENGRAIS, SEMENCES... 2 CROCHETS LATÉRAUX VERT MATCHA POUR LE TRANSPORT D'OUTILS À MANCHE
DIM (CM) LITRAGE (L)	111 x 60 x 68,5 140
U.E.	P.10
Taube Accessoires vert matcha	 3 086960 22386 1

PANIER DE JARDIN



RÉF.	010526
Désignation	PANIER DE JARDIN FLEXIBLE 43 L GRADUÉ
DIM (CM) LITRAGE (L)	Ø46 x 37 43
U.E.	S.10
Vert	 3 086960 20995 7

SEAU A COMPOST



RÉF.	013119
Désignation	SEAU COMPOST 6 L AVEC COUVERCLE
DIM (CM) LITRAGE (L)	24,8 x 23,8 x 24,3 6
U.E.	C.6
Gris Anthracite	 3 086960 23516 1
Vert eucalyptus Anse Gris	 3 086960 26045 3

PANIER DE RAMASSAGE AVEC ANSE



RÉF.	019546	019726
Désignation	PANIER DE RAMASSAGE PETIT MODÈLE ANSE NON MONTÉE	PANIER DE RAMASSAGE GRAND MODÈLE ANSE NON MONTÉE
DIM (CM) LITRAGE (L)	50 x 34,5 x 16 13	52 x 35 x 18 18
U.E.	S.10	S.10
Gris anthracite	 3 086960 26412 3	
Vert Matcha	 3 086960 24604 4	
Vert Canada	 3 086960 02653 0	 3 086960 02825 1



SACS DE RAMASSAGE



RÉF.	010530	010531
Désignation	SAC DE RAMASSAGE SOUPLE 141L	SAC DE RAMASSAGE POP UP 117L
DIM (CM)	Ø50 x 72	Ø50 x 60
U.E.	C.12	C.12
Vert canada	 3 086960 26152 8	 3 086960 26153 5

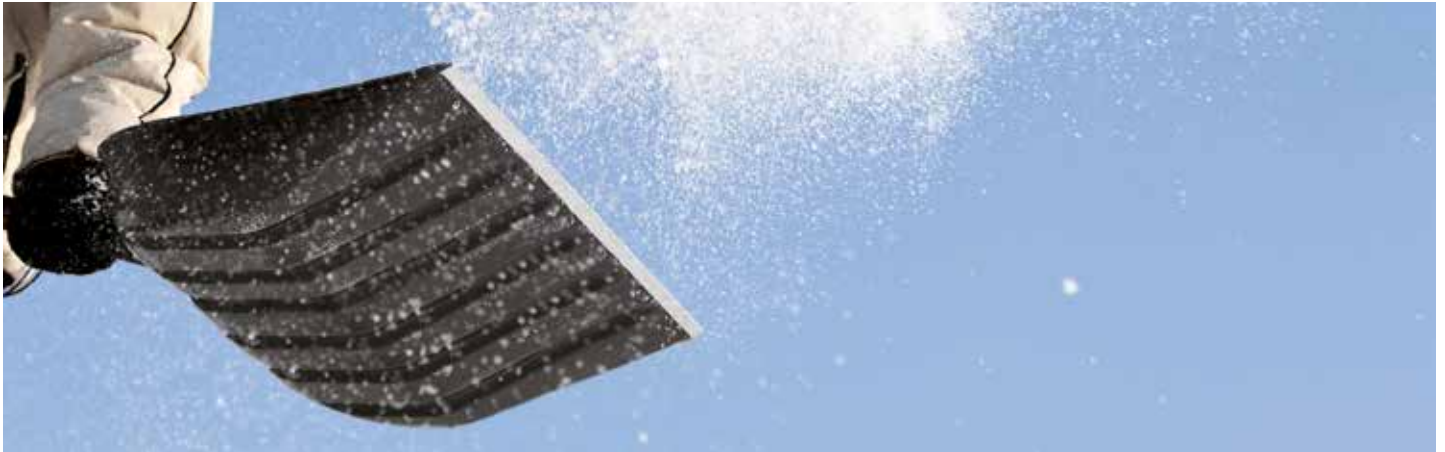

PELLE À NEIGE TÉLESCOPIQUE



RÉF.	010389
Désignation	PELLE DE DÉNEIGEMENT TÉLESCOPIQUE IDÉAL POUR LES VOITURES - GRIP SUR LE MANCHE POUR UNE MEILLEURE PRÉHENSION, PLASTIQUE TRÈS RÉSISTANT. MANCHE TÉLESCOPIQUE JUSQU'À 1M EN HAUTEUR
DIM (CM)	25 x H 73 à 97 cm
U.E.	C.12
Gris	 3 086960 213794

PELLE DE RAMASSAGE



RÉF.	010390	010391
Désignation	PELLE AVEC MANCHE EN BOIS PELLE VERTE - MANCHE BOIS - LIVRÉE MONTÉE	PELLE AVEC RENFORT MÉTAL MANCHE BOIS - LIVRÉE MONTÉE
DIM (CM)	145 x 46 Manche bois ø2,8	145 x 46 Manche bois ø2,8
U.E.	B.16	B.16
Vert Canada	 3 086960 120436	
Gris		 3 086960 176372

PELLE PLASTIQUE



RÉF.	010388
Désignation	PELLE PLASTIQUE MANCHE EN ALUMINIUM AVEC GRIP ET POIGNÉE. RENFORT ALU SUR LA PELLE.
DIM (CM)	40 x 32 x 130
U.E.	B.24
Noir	 3 086960 230463

PELLE ALU



RÉF.	010418
Désignation	PELLE ALU MANCHE EN BOIS. POIGNÉE PLASTIQUE. PELLE EN ALUMINIUM 2MM D'ÉPAISSEUR GRANDE QUALITÉ
DIM (CM)	36 x 45 x 130
U.E.	B.10
Alu	 3 086960 230470

BAQUETS RONDS



RÉF.	019522	019525	019534	019926
Désignation	BAQUET ROND 30 L	BAQUET ROND 50 L	BAQUET ROND 75 L	BAQUET ROND 110 L
DIM (CM) LITRAGE (L)	58 x Ø52 x 26,5 30	63 x Ø56 x 32 50	69,5 x Ø61 x 39 75	80 x Ø70 x 46 110
U.E.	F.15	F.10	F.5	F.5
Vert Canada	 3 086960 026301	 3 086960 026356	 3 086960 026424	 3 086960 029371

BAQUETS OVALES



RÉF.	019528	019752
Désignation	BAQUET OVALE 50 L	BAQUET OVALE 70 L
DIM (CM) LITRAGE (L)	65 x 50 x 30 50	80 x 58 x 33 70
U.E.	F.10	F.5
Vert Canada	 3 086960 026387	 3 086960 028299

EAN OUTILLAGE ET UTILITAIRE



SEAUX AGRICOLES



RÉF.	019591	019592	019593
Désignation	SEAU AGRICOLE 10 L	SEAU AGRICOLE 13 L	SEAU AGRICOLE 16 L
DIM (CM) LITRAGE (L)	Ø28 x 24,5 10	Ø32 x 27 13	Ø33 x 29 16
U.E.	S.10	S.10	S.10
Vert Canada	3 086960 027353	3 086960 027360	3 086960 027384

SEAUX À VENDANGE ET SEAUX À VEAUX



RÉF.	059523	010523
Désignation	SEAU 15,5 L AVEC ANSE EN MÉTAL ET POIGNÉE ASPECT BOIS	SEAU 15,5 L AVEC ANSE EN MÉTAL
DIM (CM) LITRAGE (L)	Ø35 x 22,5 15,5	Ø35 x 22,5 15,5
U.E.	S.25	S.25
Noir	3 086960 033576	
Vert Canada		3 086960 005757

POUBELLE À ROULETTES



RÉF.	010633
Désignation	POUBELLE 110 L À ROULETTES
DIM (CM) LITRAGE (L)	55 x ø58 x 81 110
U.E.	S.2
Noir	3 086960 113452
Vert Canada	3 086960 013165

CORPS DE POUBELLE IMMEUBLE



COUVERCLES DE POUBELLE



RÉF.	060556	060557	013011
Désignation	CORPS DE POUBELLE 30 L	CORPS DE POUBELLE 50 L	CORPS DE POUBELLE 75 L
DIM (CM) LITRAGE (L)	46,5 x ø38,5 x 38 30	51,5 x ø48 x 44 50	63 x ø55 x 49 75
U.E.	F.10	F.5	F.8
Vert Canada	3 086960 026790	3 086960 026813	3 086960 092009

RÉF.	010618	050621	013012
Désignation	COUVERCLE POUBELLE 30 L	COUVERCLE POUBELLE 50 L	COUVERCLE POUBELLE 75 L
DIM (CM) POUR POUBELLE LITRAGE (L)	43,5 x ø40,5 x 5,5 30L - 060556	52 x ø48 x 8 50L - 060557	61 x ø57 x 9,5 75L - 013011
U.E.	F.5	F.5	F.8
Vert Canada	3 086960 095741	3 086960 095369	3 086960 092016

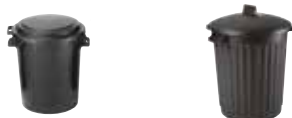

POUBELLES D'IMMEUBLE AVEC COUVERCLE PLAT



	RÉF.	079557	079558	013001
	Désignation	POUBELLE 50 L	POUBELLE 80 L	POUBELLE 80 L ECO
	DIM (CM) LITRAGE (L)	54 x ø48 x 49,5 50	61 x ø54,5 x 56 80	57 x ø52 x 65 80
	U.E.	F.5	F.5	P.60
Noir	 	 3 086960 036614	 3 086960 036638	 3 086960 091996

POUBELLE 100L À ROULETTES



	RÉF.	010644
	Désignation	POUBELLE 100L AVEC PÉDALE ET ROULETTES
	DIM (cm) Litrage (L)	50 x 48,6 x 83,5 100L
	U.E.	S.4
Gris Anthracite Couvrete et accessoires noirs	 	 3 086960 261474



JERRICANS ALIMENTAIRES EXTRA FORT



	RÉF.	010584	010585	010586	010587
	Désignation	JERRICAN EXTRA FORT 5 L AVEC BOUCHON «SIMPLE» + ROBINET	JERRICAN EXTRA FORT 10 L AVEC BOUCHON «SIMPLE» + ROBINET	JERRICAN EXTRA FORT 15 L AVEC BOUCHON «SIMPLE» + ROBINET	JERRICAN EXTRA FORT 20 L AVEC BOUCHON «SIMPLE» + ROBINET
	DIM (CM) LITRAGE (L)	23,5 x 11 x 30 5	29 x 15 x 35 10	32 x 16 x 38 15	39 x 17 x 44 20
	U.E.	S.15	S.10	S.10	S.5
Naturel		 3 086960 009960	 3 086960 009977	 3 086960 009991	 3 086960 010010

JERRICAN SPECIAL CARAVANE



	RÉF.	010987
	Désignation	JERRICAN 35 L CERTIFIÉ CONTACT ALIMENTAIRE AVEC GRANDE OUVERTURE POUR POMPE ET ROBINET
	DIM (CM) LITRAGE (L)	39,5 x 24 x 47,5 35
	U.E.	S.6
Naturel		 3 086960 023379



JERRICANS ALIMENTAIRES



	RÉF.	010510	010161	010162
	Désignation	JERRICAN AVEC BEC VERSEUR 5 L ET LOGÉ DANS LE JERRICAN NORME CONTACT ALIMENTAIRE	JERRICAN AVEC BEC VERSEUR 10 L ET LOGÉ DANS LE JERRICAN NORME CONTACT ALIMENTAIRE	JERRICAN AVEC BEC VERSEUR 20 L ET LOGÉ DANS LE JERRICAN NORME CONTACT ALIMENTAIRE
	DIM (CM) LITRAGE (L)	23,5 x 11 x 30 5 Verseur	32,1 x 17,8 x 30,1 10 Verseur	35 x 23 x 36,5 20 Verseur
	U.E.	S.20	S.10	S.5
Naturel		 3 086960 004750	 3 086960 116293	 3 086960 116309



JERRICAN PLIABLE



	RÉF.	010542
	Désignation	JERRICAN 15 L PLIABLE AVEC ROBINET, CERTIFIÉ CONTACT ALIMENTAIRE
	DIM (CM) LITRAGE (L)	25 x 25 x 25 (6 cm plié) 15
	U.E.	C.12
Naturel		 3 086960 213800

FÛTS



	RÉF.	010558	010559
	Désignation	FÛT MULTI-USAGES 25 L «FÛTÉ» ANTICHOC - CADENASSABLE - ETANCHE	FÛT MULTI-USAGES 50 L «FÛTÉ» ANTICHOC - CADENASSABLE - ETANCHE
	DIM (CM) LITRAGE (L)	29 x 29 x 46 25	36 x 36 x 53 50
	U.E.	S.4	S.3
Naturel		 3 086960 216849	 3 086960 216856

EAN OUTILLAGE ET UTILITAIRE



JERRICANS MÉTALLIQUES



RÉF.	010176	010167	010168	010177
Désignation	JERRICAN MÉTALLIQUE POUR TRANSPORT PRODUIT DANGEREUX 5 L AVEC BOUCHON SÉCURISÉ HOMOLOGUÉ TRANSPORT DE PRODUITS DANGEREUX (NORME UN)	JERRICAN MÉTALLIQUE POUR TRANSPORT PRODUIT DANGEREUX 10 L HOMOLOGUÉ TRANSPORT DE PRODUITS DANGEREUX (NORME UN)	JERRICAN MÉTALLIQUE POUR TRANSPORT PRODUIT DANGEREUX 20 L HOMOLOGUÉ TRANSPORT DE PRODUITS DANGEREUX (NORME UN)	BEC VERSEUR POUR JERRICANS MÉTALLIQUES
DIM (CM) LITRAGE (L)	24,7 x 10,6 x 27,5 5	28,2 x 13 x 39 10	34,5 x 16,5 x 46,8 20	Bec verseur
U.E.	C.5	C.5	C.5	S.5
Vert Kaki				

BIDON À MAZOUT



RÉF.	010662
Désignation	BIDON À MAZOUT 11 L AVEC FILTRE ET COUVERCLE VISSANT
DIM (CM) LITRAGE (L)	65 x 20 x 31,5 11
U.E.	S.6
Noir + couv. Rouge	

JERRICANS «PROMO»



RÉF.	019553	019554	019555
Désignation	JERRICAN 5 L «PROMO» AVEC BEC VERSEUR RIGIDE ET LOGÉ DANS LE JERRICAN	JERRICAN 10 L «PROMO» AVEC BEC VERSEUR RIGIDE ET LOGÉ DANS LE JERRICAN	JERRICAN 20 L «PROMO» AVEC BEC VERSEUR RIGIDE ET LOGÉ DANS LE JERRICAN
DIM (CM) LITRAGE (L)	23,5 x 11 x 30 5	29 x 15 x 36 10	37,5 x 17 x 45 20
U.E.	S.20	S.10	S.5
Bleu métal			

JERRICAN DOUBLE



RÉF.	010169
Désignation	JERRICAN DOUBLE COMPARTIMENT 6 L POUR ESSENCE - 2,5 L POUR HUILE AVEC BEC VERSEUR RIGIDE HOMOLOGUÉ TRANSPORT DE PRODUITS DANGEREUX (NORME UN)
DIM (CM) LITRAGE (L)	31,8 x 16,7 x 31,4 6 + 2,5
U.E.	S.6
Orange	

JERRICANS «HYDROCARBURES»



RÉF.	019160	019161	019162
Désignation	JERRICAN PLASTIQUE POUR HYDROCARBURE 5 L HOMOLOGUÉ TRANSPORT DE PRODUITS DANGEREUX (NORME UN)	JERRICAN PLASTIQUE POUR HYDROCARBURE 10 L HOMOLOGUÉ TRANSPORT DE PRODUITS DANGEREUX (NORME UN)	JERRICAN PLASTIQUE POUR HYDROCARBURE 20 L HOMOLOGUÉ TRANSPORT DE PRODUITS DANGEREUX (NORME UN)
DIM (CM) LITRAGE (L)	32,1 x 17,8 x 18,2 5	32,1 x 17,8 x 30,1 10	35 x 23 x 36,5 20
U.E.	S.10	S.10	S.5
Rouge			



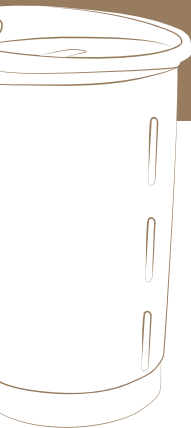

EAN CHAUFFAGE



JURA MONTANIA





RÉF.	010488
Désignation	SAC À GRANULÉS EN TISSU
DIM (cm) Litrage (L) Contenance pellets (KG)	Ø44 x 45 60L 30
U.E.	C.12
Noir - Gris	 3 086960 265335

RÉF.	010487
Désignation	SAC À GRANULÉS EN FEUTRINE
DIM (cm) Litrage (L) Contenance pellets (KG)	40 x 40 x 40 60L 40
U.E.	C.12
Gris béton - Gris anthracite	 3 086960 265574

JURA MONTANIA



RÉF.	010479	010483	010481	010478	010482
Désignation	DISPLAY PELLE À GRANULÉS	DISPLAY PELLE XL À GRANULÉS	CARRÉ STONE	COFFRE À GRANULÉS	COFFRE XL À GRANULÉS
DIM (cm) Litrage (L) Contenance pellets (KG)	11,8 x 11,8 x 18,2 1L 0,7	37,2 x 33,7 x 38,6 2,4L 1,5	ø39,7 x 60,5 36L 20	ø39,7 x 60,5 38L 25	49,6 x 37,9 x 65,9 70L 45
U.E.	D.12	D.20	S.4	S.5	S.4
Noir	 3 086960 265467	 3 086960 264536	 3 086960 264505	 3 086960 261443	 3 086960 264512



NOTES



NOTES

A series of horizontal dotted lines for taking notes, spanning the width of the page.





COULEURS

COLORS
FARBEN
COLORES

- 1 NATUREL
Natural. Natur. Natural
- 2 BLANC
White. Weiss. Blanco
- 3 BLANC CÉRUSÉ
Cerused white.
"Cerusiertes" weiss
Blanco de plomo
- 6 TAUPE
Mole color, Braun, Tostado
- 8 GRIS ANTHRACITE
Anthracite grey.
Anthracite grau.
Antracita
- 10 VERT
Green. Grün. Verde
- 14 ORANGE
Orange. Orange. Anaranjado
- 15 ROUGE
Red. Rot. Rojo
- 16 BLEU
Blue. Blau. Azul
- 20 TERRE CUITE
Terracotta.
Terrakotta.
Terracota
- 21 VERT CANADA
Canada green.
Kanada grün.
Verde Canadá
- 22 NOIR
Black. Schwarz. Negro
- 26 VERT
Green. Grün. Verde bambu
- 27 VERT MÉTAL
Green. Grün. Verde metal
- 28 BEIGE / SABLE
Beige. Beige. Beige
- 29 ALU
Alu. Alu. Aluminio
- 30 GRIS
Grey. Grau. Gris
- 31 GRIS CÉRUSÉ
Cerused grey.
"Cerusiertes" Grau.
Gris de plomo
- 32 GRIS FONCÉ
Dark grey. Dunkel Grau.
Gris oscuro
- 37 ARDOISE
Dark grey.
Dunkel Grau.
Color de pizarra
- 42 BLEU METAL
Metal blue. Metal blau.
Azul metal
- 47 ROUGE RUBIS
Ruby red. Rubinrot. Rojo rubi
- 48 GRIS MARTELÉ
Grey. Grau. Gris
- 52 GRIS GALET
Grey. Grau. Gris
- 53 GRIS BÉTON
Cement grey. Beton Grau.
Gris cemento
- 56 MATCHA
Matcha. Matcha. Matcha
- 57 BLEU PROFOND
Deep blue. Tiefblau.
Azul profundo
- 65 FRAMBOISE
Raspberry. Himbeere
Frambuesa.
- 69 JAUNE
Yellow. Gelb. Amarillo.
- 75 VERT EUCALYPTUS
Eucalyptus green. Eukalyptus
Grün. Verde eucalipto.
- 76 BLANC IVOIRE
Ivory white. Elfenbein Weiß
Blanco marfil
- 78 VERT LAURIER
Laurel. Lorbeer. Laurel
- 79 JAUNE CURCUMA
Turmeric. Kurkuma. Cúrcuma
- 80 NUDE
Nude. Nude. Nude
- 83 BOURGOGNE
Burgundy. Weinrot.
Borgoña
- 84 BLEU JEAN
Denim blue. Jeansblau. Azul
tejano
- 85 ASSORTIMENT
Assortment. Sortiment. Surtido.

CONTACT

Ets Georges David
36 rue des Carmes
01100 Oyonnax
FRANCE

+33 (0)4 74 77 80 44
info@groupe-eda.com

EDA GmbH
Lebacher Strasse 4
66113 Saarbrücken
DEUTSCHLAND

EDA Soluciones Productos
Calle Poeta Joan Maragell, 39
28020 Madrid
ESPAÑA

EDA Benelux / Plastinova
Heernisse 16
8600 Diksmuide
BELGIQUE

